



TODAY'S PERFORMANCE[®]

BORN / DESIGNED / BUILT
IN
AMERICA



WHY FOLLOW WHEN YOU CAN LEAD

When we started BBK in 1988 our mission was to design & build products for the all new generation of fuel injected muscle cars coming out of Detroit starting with the then new Mustang 5.0L. Back then with almost no performance products available to enthusiasts like ourselves, BBK was born along with some industry firsts such as the first air intake systems, aftermarket performance throttle bodies and a line of tuned length shorty headers.

Fast forward nearly thirty years and BBK has grown to become the number one manufacturer of performance products for the modern fuel injected muscle cars and trucks, with over 500 performance products and counting. Today our facilities on both coasts total nearly 200,000 ft of state of the art design, manufacturing and distribution space. While we might be a much larger organization than what we started with, the two of us still spend each and every day working with one of the best teams in the industry dedicated to designing & building the best possible performance products right here in the USA.

While the BBK line has grown greatly over the years, never before has the American performance scene been better or stronger. With over 700HP from factory Hemi models, over 500HP from the new GT350 and over 450HP out of the all new LT1 equipped Camaro SS - Detroit is building the best canvas ever for our team of performance engineers. We are more excited than ever to share with fellow enthusiasts the joy that comes from bolted on more horsepower and maintaining the same level of quality & reliability you expect from the factory.

BRIAN MURPHY
PRESIDENT & CEO

KEN MURPHY
VP & CHIEF DESIGNER



BRIAN MURPHY

2 / www.bbkperformance.com





CONTENTS

INSIDE BBK	1-5
THROTTLE BODIES	6-17
INTAKES/FUEL COMPONENTS	18-23
MASS AIR METERS	24
COLD AIR INTAKES	25-35
UNDERDRIVE PULLEYS	36/37
PERFORMANCE EXHAUST	38-57
GRIPP SUSPENSION	58-60
CLUTCH QUADRANT CABLE KITS	61
NEW PRODUCTS	62/63

DESIGNED IN AMERICA

Equipped with the latest test equipment and two dynos, our BBK engineering team works each day designing and testing dozens of new products that are added to our BBK offerings each year. From the initial CAD drawings to the final fitment and testing of each part before it is released to production, our goal is to ensure that each product will perform beyond your expectations. To check out a video of what it takes to design some of your favourite BBK performance products please see our website at www.bbkperformance.com



WATCH OUR BBK FACTORY
TOUR ONLINE



DYNO PROVEN PERFORMANCE





STATE OF THE ART MANUFACTURING FACILITIES



BUILT IN AMERICA

While our team utilizes cutting edge robotic welding on many components, it's still up to our dedicated craftsmen to ensure the perfect fit and finish of our high quality performance products. These skilled craftsmen use good old fashioned hard work and an eye for detail to ensure each and every product will make it through our vigorous inspection procedures. Even such simple yet important test phases such as pressure testing of headers ensures that your BBK products will not only install and fit the way they were designed to, but also meet demands of today's computer controlled vehicles.

Each and every BBK product is built utilizing the latest in computer controlled mandrel bending and CNC machine for maximum accuracy and quality. These processes also ensure a consistent level of quality and the most performance possible. In addition to CNC bending our team also utilizes robotic plasma cutting for aircraft quality tolerances on even the smallest detail such as the hole for an oxygen sensor fitting.



DODGE 85MM & 90MM 5.7L / 6.1L / 6.4L HEMI UNITS

POWER-PLUS®
S E R I E S

SEE
ONLINE
VIDEO
NOW AVAILABLE
FOR ALL YEARS



- + Bolt-On 14–24 Horsepower
- + Easy Bolt-On Includes New OEM Electronics And Drive Motor
- + All New CNC Machined BBK Casting, Not Bored Out Stock Unit

Available in both 85mm & 90mm versions our performance throttle bodies for 5.7L, 6.1L & 6.4L models have quickly become a top bolt-on for owners of Challenger, Charger, Chrysler 300 and, Ram and Jeep models. Delivering an easy 14–24 horsepower at the wheels, these new units really wake up the performance of the awesome Hemi engines and are an easy bolt-on and plug in as they come completely assembled with all new electronics and OEM style drive motor. For what other companies are charging for a bored out stock unit, our BBK throttle bodies feature an all new aluminum casting, dozens of top quality components and do not require any items from your stock unit

1781—85mm Performance Throttle Body (2003–2012 5.7L, 6.1L & 6.4L HEMI models)

1782—90mm Performance Throttle Body (2003–2012 5.7L, 6.1L & 6.4L HEMI models)

NEW1842—85mm Performance Throttle Body (2013–2016 5.7L & 6.4L HEMI models)

NEW1843—90mm Performance Throttle Body (2013–2016 5.7L & 6.4L HEMI models)

50STATELEGAL

EO# PENDING

See Website For Update

GENERAL
MOTORS

FORD

DODGE

DODGE / JEEP 70MM 4.7L

- + Bolt-On 8–12 Horsepower
- + Fits Ram, Durango, Dakota And Jeep Models 1999–06

Our 70mm performance throttle bodies for various Dodge / Jeep 4.7L equipped models are an easy way to bolt-on 8–12 horsepower without sacrificing mileage or drivability. Like our other popular “Power Plus” units these throttle bodies are brand new from an all new computer machined casting to all top quality components making it a thirty minute do it yourself swap.



1723—70mm Performance
Throttle Body (1999–2006
Dodge/Jeep)

50STATELEGAL

EO# PENDING

See Website For Update

DODGE / JEEP TWIN 52MM 5.2 / 5.9L

- + Bolt-On 10–14 Horsepower
- + Fits Ram, Durango, Dakota And Jeep Models 1999–03

Even owners of the 5.2L & 5.9L Dodge and Jeep models can add 10–14 horsepower and improved towing capabilities with this twin 52mm performance throttle body assembly. With it's all new CNC machined casting and OEM quality components this unit comes complete and ready to bolt-on and will work great with factory or aftermarket tunes.

1722—Twin 52mm Performance Throttle Body (1999–03 Dodge Truck/Jeep)



50STATELEGAL

EO# PENDING

See Website For Update

PERFORMANCE THROTTLE BODIES

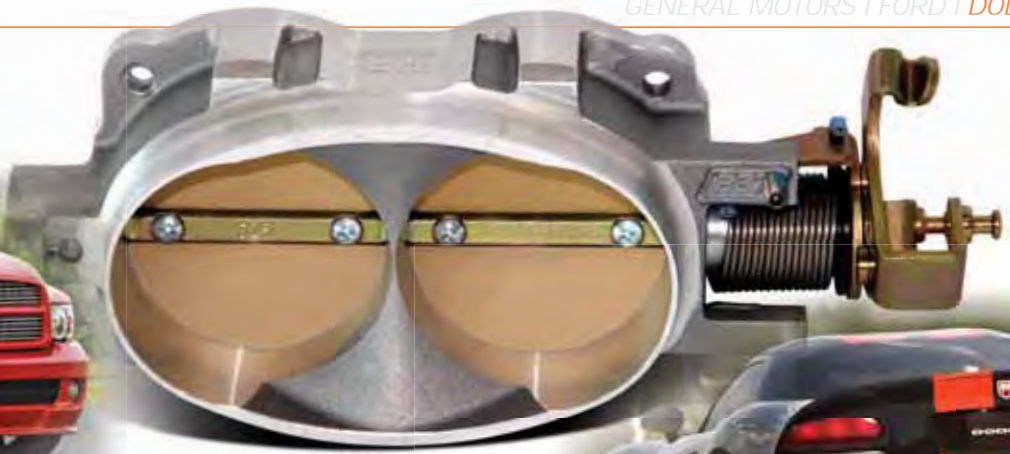

DODGE VIPER / RAM TWIN 67MM / SRT-10

- + Bolt-On Up to 22 Horsepower
- + All New CNC Machined BBK Casting And Components

One simple and sure way to add easy horsepower to Dodges massive V10 motors that can be found in the popular Viper and SRT-10 Ram trucks is with one of our huge twin 67mm performance throttle bodies. On otherwise stock application our engineers have measured dyno proven gains of 22 rear wheel horsepower with even more on tap when vehicles are equipped with other popular upgrades such as exhaust, air intakes and tuners. As with all BBK throttle bodies this unit is a complete assembly ready to bolt-on and features an all new computer machined aluminum casting and aircraft quality components. When your ready to unleash even more horsepower our of your V10 monster look no further.

1767—Twin 67mm Performance Throttle Body (2003–06 Viper V10)
 1776—Twin 67mm Performance Throttle Body (SRT-10 Ram Truck)

50STATELEGAL

EO# PENDING
 See Website For Update



POWER-PLUS®
 S E R I E S

62MM 4.0L JEEP MODELS

- + Bolt-On 7–10 Horsepower
- + All New CNC Machined Components
- + Fits 1991–06 Models

Representing one of the most versatile and rugged vehicles ever produced, the popular 4.0L Jeep has been a top model with enthusiasts for decades. One easy way to increase this reliable 4.0L engine is with our popular and proven 62mm performance throttle body which works great on stock applications as well as with other add ons such as air intakes, exhaust and custom tuners. Sold as a brand new complete assembly this unit starts life with a fully CNC machined new aluminum casting and features all top quality components to ensure maximum performance and reliable on the street or the trails.

1724—62mm Performance Throttle Body (1991–03 4.0L Jeep Wrangler and Cherokee)
 17240—62mm Performance Throttle Body (2004–06 4.0L Jeep Wrangler and Cherokee)



50STATELEGAL

EO# PENDING
 See Website For Update

www.bbkperformance.com

DODGE

1986-95 MUSTANG 5.0L

- + Top Seller For 20 Years
- + Available In 65mm, 70mm, 75mm And 80mm Units
- + Matching EGR Plates Available
- + All 50 State Smog Legal

When our BBK team first introduced the performance throttle body to the aftermarket, it was this 1986–93 5.0L version back in 1988 when the 5.0L Mustang was quickly becoming the favorite with drag racers and enthusiasts. Fast forward with the hot new 2011–16 5.0L Mustang reintroduced and these original 1986–93 and 1994–95 units are still one of our top sellers with thousands of happy enthusiast over the years. As with all BBK performance throttle bodies, each unit is designed and built right here in the USA ensuring unmatched performance, quality and overall value. When you see some of the other low quality knock offs on the market ask where they are built and you will find out in China and one comparison will make it clear why they might be priced slightly less than our BBK units. BBK is serious about building the best products for American vehicles right here in the USA and we proudly stand behind each and every performance part.

- 1500—70mm Throttle Body & EGR Spacer Kit (1986 – 93 5.0L Mustang)
- 1600—75mm Performance Throttle Body & EGR Spacer Kit (1986 – 93 5.0L Mustang)
- 1517—65mm Performance Throttle Body (1986 – 93 5.0L Mustang)
- 1518—65mm EGR Spacer Plate (1986–93 5.0L Mustang)
- 1501—70mm Performance Throttle Body (1986 – 93 5.0L Mustang)
- 1502—70mm EGR Spacer Plate (1986–93 5.0L Mustang)
- 1503—75mm Performance Throttle Body (1986 – 93 5.0L Mustang)
- 1504—75mm EGR Spacer Plate (1986–93 5.0L Mustang)
- 1514—80mm Performance Throttle Body (1986 – 93 5.0L Mustang)
- 1522—65mm Performance Throttle Body (1994 – 95 Mustang GT)
- 1523—70mm Performance Throttle Body (1994 – 95 Mustang GT)
- 1524—75mm Performance Throttle Body (1994 – 95 Mustang GT)



1996-04 4.6L COBRA, MACH1 & BULLITT & LIGHTNING TRUCK TWIN 62MM & 65MM

- + Bolt-On 12–14 Horsepower
- + Flows Up to 45% Better Than Stock
- + All New CNC Machined Casting And Components

Mustang enthusiasts have long understood the great benefits of performance throttle bodies with there real world horsepower increases, easy installation and OEM drivability. The high breather 1996–04 4.6L 4V models are no exception and actually respond even better than there 4.6L 2V counterparts as these high reeving motors love more air flow. Available in both twin 62mm & twin 65mm versions depending on the model, these throttle bodies offer the same well known details such as an all new computer machined casting, high quality components and ready to bolt-on assembly for an easy and fast installation.

- 1705—Twin 62mm Performance Throttle Body (1996–01 Mustang Cobra, 2003–04 Mach 1 and 2001 Bullitt)
- 1711—Twin 65mm Performance Throttle Body (1996–01 Mustang Cobra, 2003–04 Mach 1 and 2001 Bullitt)
- 17110—Twin 65mm Performance Throttle Body (2003–04 Mustang Cobra)
- 1755—Twin 65mm Performance Throttle Body (1993–03 Ford Lightning Truck)





1996-04 MUSTANG GT 4.6L 78MM & 73MM THROTTLE INTAKE

- + Bolt-On 12–15 Horsepower In An Hour
- + Much Cleaner And Better Flow Than Separate Elbow & Throttle Body
- + Comes In Polished And Durable Powder Coated Finish

Optional Polished Version

Another performance first from BBK Performance—the all new 78mm BBK Throttle Intake incorporates a high flow intake plenum and a larger 78mm BBK Throttle Body all in one great performing unit. Add 12–15 horsepower with this direct bolt-on. This patent pending design has all the quality features you would expect from a BBK product. Built from lightweight 356 aluminum castings, this kit comes complete with all the necessary hardware and horsepower!

1780—4.6 GT 78mm 2V BBK Throttle Intake (1996–04) – Charcoal
 17800—4.6 GT 78mm 2V BBK Throttle Intake (1996–04) – Polished
NEW 17801—4.6 GT 73mm 2V BBK Throttle Intake (1996–04) – Charcoal

50STATE LEGAL

CA EO# D-245-17

MUSTANG / F-SERIES / EXPEDITION 70MM & 75MM 4.6 / 5.4L THROTTLE BODIES

- + Fits 1996–04 Mustang GT, 1997–03 F-Series Truck.
- Also Fits Most 1990–95 4.6L 2V Models
- + Bolt-On 12–15 Horsepower

Looking for an easy bolt-on horsepower upgrade for your favorite Ford Mustang, F-Series or Expedition Look no further than one of these popular “Power Plus” series performance throttle bodies available for 1996–04 Mustang GT, 1997–03 F-Series/Expedition as well as other Ford 4.6L 2V applications. With typical gains of 8–15 horsepower as well as increased throttle response these are great for overall performance as well as increased towing capacity on truck applications. While there are a few China knock offs on the market, none come close to the American built quality and design as our units as BBK was the first to engineer such a throttle body. A brand new computer machined casting, OEM quality components and all USA built construction and assembly ensure the unmatched quality and performance guaranteed.



SEE
ONLINE
VIDEO

1700—70mm Performance Throttle Body (1996–04 Mustang GT)
 1701—75mm Performance Throttle Body (1996–04 Mustang GT, 1997-03 5.4L F250)
 1703—75mm Performance Throttle Body
 (Fits all 1990–95 4.6L 2V models, 1997–03 4.6L/5.4L F-Series/Expedition)

50STATE LEGAL

EO# D-245-15

www.bbkperformance.com

POWER-PLUS®



2005-14 MUSTANG GT, GT500 & SHELBY

- + Available In 62mm & 65mm
- + Bolt-On Up to 20 Horsepower With Stock Tune
- + All New CNC Machined

Owners of Ford's latest generation pony car can now add one of the most popular power adders with our latest performance throttle body offerings. Now available for 4.0L V6, 4.6L GT, GT500 and Shelby models, these new throttle bodies offer awesome performance gains while utilizing a factory calibrated electronic throttle control for a trouble free installation. While other manufacturers have had to recommend the use of power programmers to offset some inherent calibration problems, our use of an OEM style injection molded gear assembly allows use with the factory program or an aftermarket programmer. In over twenty years of building performance throttle bodies, our engineers have seen some of the biggest gains to date with 14–17 rear wheel horsepower on typical GT models with otherwise stock motors, including the factory computer & program. The V6 units are delivering 8–10 additional horsepower on otherwise stock models, and with even bigger gains when used in conjunction with one of our new cold-air induction systems. Look at our in-depth product and installation information along with dyno results on www.bbkperformance.com

1763—Twin 62mm Performance Throttle Body (2005–2010 4.6L Mustang 3V)

1764—Twin 65mm Performance Throttle Body (2007–2014 GT500 / 2005–2010 V10 F-Series)

50STATELEGAL

CA EO# D-245-17

2011-16 MUSTANG GT / F-150 THROTTLE BODY

NOW AVAILABLE
FOR 2015-2016 GT

- + Bolt-On 8–12 Horsepower
- + Comes Complete With New OEM Drive Motor And Electronics
- + 85mm Flow Up to 35% Over Stock



As the originator and largest source of performance throttle bodies in the aftermarket, our engineers went right to work on our latest units for the 2015-2016 Coyote models. While our popular throttle bodies for the 11-14 Coyote look like the same unit, the 2015-2016 version actually uses a unique casting and electronics but like the earlier models is designed as a true bolt-on and plug in with no tune required. Engineered to fit both the Coyote equipped Mustang & F150 truck applications, our latest Power Plus Series Coyote throttle bodies are available in either 85mm or 90mm versions and are good for a solid 8-12 rear wheel horsepower along with improved throttle response and torque.



50STATELEGAL

CA EO# D-245-17

1821—85mm Performance Throttle Body
(2011–15 Mustang 5.0L, Boss 302, 2012 5.0L F-Series Truck)

18210—19mm Performance Throttle Body
(2011–15 Mustang 5.0L, Boss 302, 2012 5.0L F-Series Truck)

NEW 1806—85mm Performance Throttle Body
(2015-2016 Coyote 5.0L Mustang & F-Series Truck)

NEW 1807—90mm Performance Throttle Body
(2015-2016 Coyote 5.0L Mustang & F-Series Truck)

1994-04 MUSTANG V6

- + Bolt-On 7-10 Horsepower
- + All New CNC Machined Casting And Components

With enthusiasts continually looking to improve performance while maintaining great mileage numbers, the number of V6 Mustang enthusiasts continues to grow each year as the factory and companies like BBK are able to engineer more parts. For proven and affordable performance owners have been keen to bolt-on our popular 3.8L performance throttle bodies for the 1994-04 Mustang V6. Delivering 7-10 bolt-on horsepower each unit is a brand new USA built assembly with the best design and finest components for unmatched performance and value.

- 1548—56mm Performance Throttle Body (1994-98 3.8L Mustang V6)
- 1552—65mm Performance Throttle Body (1999-00 3.8L Mustang V6)
- 1652—65mm Performance Throttle Body (2001-04 3.8L Mustang V6, 1997-03 4.2L V6 F-Series)



50STATELEGAL CA EO# D-245-17

2005-10 MUSTANG 4.0L V6 70MM

Simply bolt-on this new 70mm performance throttle body and see gains of 7-10 horsepower from your 4.0L V6 2005-10 Mustang along with improved throttle response and OEM drivability. Designed and engineered work with your factory drive motor to keep costs down this new throttle body flows over 35% better than stock and is built here in the USA with all new computer machined casting and components. This item works on stock V6 models and even better with popular upgrades such as our air intake kits, exhaust or an aftermarket tune.



- 1765—70mm Performance Throttle Body (2005-10 Mustang 4.0L V6)

50STATELEGAL

CA EO# D-245-17

MUSTANG V6 / F150 ECCOBOOST / F150 V6 73MM 3.7L / 3.5L

Just as we did with the all new 2011-16 5.0L Mustang, we went to work on a variety of popular BBK bolt-ons for the newest generation 3.7L V6 which already tops 300 horsepower and 29MPG highway in stock form. This all new 73mm performance throttle body comes complete with new electronics and drive motor to simplify installation and is good for 8-11 horsepower over the factory unit. Like all BBK throttle bodies, this unit is built in the USA and will work with your factory or aftermarket tune as well as in stock form or a host of other performance bolt-ons. Who would of thought twenty five years ago when the hot 5.0L Mustang was making 225 horsepower that owners of the current breed would be making well over 300 horsepower and nearly 30MPG with a V6.

- 1822—73mm Performance Throttle Body (2011-16 Mustang 3.7L V6, 2011-15 F150 3.7L, 2011-15 3.5L F150 Eccoboost)



50STATELEGAL

CA EO# D-245-17

1987-03 F-SERIES

Back in the early nineties our engineering staff released these twin bore 56mm and 61mm performance throttle bodies for the then current 1987-96 303/351 and 1987-03 460 Ford truck models. Fast forward and over twenty years later with continual upgrades these units are more popular than ever as both a performance bolt-on as well as a rebuild replacement as the cost and availability of the OEM units has made the factory units unrealistic. Dyno proven on dozens of applications for 8-12 horsepower over stock each BBK throttle body is built right here in the USA with all new casting and components which are fully assembled and tested making installation an easy task.

- 3501—Twin 56mm Performance Throttle Body
(1987-96 302/351 Ford truck/RV)
- 3502—Twin 61mm Performance Throttle Body
(1987-03 460 Ford truck/RV)
- 3503—Twin 61mm Performance Throttle Body
(1987-96 302/351 Ford truck/RV)

50STATELEGAL

EO# D-245-15

POWER-PLUS®

S E R I E S



2004-10 F-SERIES / EXPEDITION

As the top seller in the USA each year, what makes more sense than bolt-on performance upgrades also designed and built right here in the USA. Our popular drive by wire performance throttle bodies will add 8-12 horsepower and improve towing capabilities while not breaking your wallet. Engineered to work with your factory drive motor, each unit starts life as a all new BBK aluminum casting which is computer machined then assembled with dozens of quality components including our unique injection molded gear set to deliver true OEM quality. These performance throttle bodies will work great with in stock form or with other popular upgrades such as our air intakes and exhaust or an aftermarket tuner.

- 1758—75mm Performance Throttle Body
(2004-06 4.6L F-Series/Expedition)
- 1759—80mm Performance Throttle Body
(2004-2010 5.4L F-Series/Expedition)

50STATELEGAL

CA EO# D-245-15



RANGER / EXPLORER MODELS

1989-08 Ford Ranger/Explorer models can also bolt-on an easy 7-10 horsepower or replace a worn out factory throttle body with one of our popular performance throttle bodies. Regardless of which year or model you can be assured of the quality that goes into each and every BBK part with all new components built right here in the USA.

- 1580—66mm Performance Throttle Body (1989-2001 4.0L Ranger/Explorer)
- NEW**1901—70mm Performance Throttle Body (2001-06 4.0L Ford Ranger)
- NEW**1902—56mm Performance Throttle Body (2006-08 3.0L Ford Ranger)



50STATELEGAL

EO# D-245-15



50STATELEGAL

EO# D-245-15

TUNED-PORT & LT-1 TWIN 52MM TWIN 58MM

- + Bolt-On 9-12 Horsepower
- + All New CNC Machined BBK Casting and Components
- + Available for Corvette, Camaro and Impala

1534—Twin 52mm Performance Throttle Body (1985–88 305/350 TPI)
 1536—Twin 58mm Performance Throttle Body (1985–88 305/350 TPI)
 1537—Twin 52mm Performance Throttle Body (1989–92 305/350 TPI)
 1539—Twin 58mm Performance Throttle Body (1989–92 305/350 TPI)
 1540—Twin 52mm Performance Throttle Body (1992–93 LT-1 5.7L)
 1542—Twin 58mm Performance Throttle Body (1992–93 LT-1 5.7L)
 1543—Twin 52mm Performance Throttle Body (1994–97 LT-1 5.7L)
 1544—Twin 58mm Performance Throttle Body (1994–97 LT-1 5.7L)

Since the early nineties, BBK performance throttle bodies have been a top bolt-on performance choice for owners of GM models equipped with the popular Tuned-Port and LT-1 models. Whether you're the owner of a Corvette, Camaro/Firebird or Impala SS, these twin 52mm & twin 58mm throttle bodies will add 9–12 horsepower to your stock application and even more with other power adders. Starting with a custom BBK 356 aluminum casting which is then fully computer machined and assembled with dozens of aircraft quality components, each throttle body is built to last as well as it will perform. Unlike carburetors which deliver air & fuel to a motor, throttle bodies are air valves and can be sized to eliminate restrictions and deliver the needed airflow for maximum power without sacrificing drivability or mileage.

1997–04 80MM CORVETTE THROTTLE BODY KIT

- + Bolt-On 10-12 Horsepower
- + Includes High-Flow Aluminum Spacer Kit
- + Brand New CNC Machined BBK Casting And Components

Owners of the popular 1997–04 C5 Corvette models already know what a great performance platform it is in stock form with great power and handling. However, if you are like most of us enthusiasts you know that a little more horsepower just makes things even that much better. C5 owners have known for years how easy it is to bolt-on one of our famous "Power Plus" series throttle bodies and get an extra 10–12 horsepower and increased throttle response without hurting mileage and drivability. Starting with a new BBK casting each unit is computer machined for exact tolerances and assembled with aircraft quality components for maximum performance and quality.

1708—80mm Performance Throttle Body (1997–04 Corvette)



50STATELEGAL

EO# D-245-17

LS-1 CAMARO FIREBIRD & GM TRUCK 80MM & 85MM

- + Direct Bolt-On adds 8-12 Horsepower
- + Fits 1998-02 Camaro / Firebird, 2004 GTO and 1999-02 4.8, 5.3, + 6.0 GM Truck Models
- + Includes High-Flow Adapter Plate

Available in both 80mm & 85mm versions for all performance levels, our performance throttle bodies for owners of LS-1 equipped Camaro/Firebird, GTO and 1999-02 GM truck model are a great performance value. Like all BBK throttle bodies these units are all new USA built assemblies for an easy installation and on these units even include a custom CNC machined aluminum adapter plate to ensure a perfect fit.

- 1709—80mm Performance Throttle Body (1998-03 LS1 Camaro/Firebird, 2004 GTO and 1999-02 GM (4.8L/5.3L/6.0L Truck)
- 17090—85mm Performance Throttle Body (1998-03 LS1 Camaro/Firebird, 2004 GTO and 1999-02 GM 4.8L/5.3L/6.0L Truck)



GENERAL MOTORS

FORD

DODGE

VORTEC GM TRUCK & H2

- + Bolt-On 7-12 Horsepower in Minutes
- + Features OEM Style Cable or Drive-By-Wire Throttle Control
- + Brand New—Not Remanufactured



- 1710—80mm GM Vortec Performance Throttle Body (1996-98 305/350/454)
- 1756—80mm GM Performance Throttle Body (1992-2002 GM 4.8, 5.3, 6.0 Truck w/Electronic Throttle Control)
- 1757—80mm GM Performance Throttle Body (2003-2006 GM 4.8, 5.3, 6.0 Truck & H2)
- 1766—80mm 8100 GM Truck/RV Performance Throttle Body (1998-2002)



2010-15 CAMARO SS & 2006-13 CORVETTE

- + Bolt-On 8-14 Horsepower
- + All New CNC Machined BBK Casting and Components
- + Utilizes Factory Drive Motor

With the introduction of the all new Camaro in 2010, the aftermarket has been busier than ever filling the needs of enthusiast for this fantastic new platform. With one of the first 2010 SS models on the west coast added to our company test fleet our engineering team went wild designing a variety of high quality bolt-ons for this new model and it's V6 sibling. After introducing such items as air intakes, headers and exhaust our staff began work on an all new version of our famous "Power Plus" series throttle bodies to maximize the potential of this potent new 6.2L LS3 motor. With an all new custom computer machined BBK casting and a full array of high quality components these units utilize the factory drive motor to deliver the best performance value. Check out www.bbkperformance.com for in depth installation and dyno results of this exciting new introduction



- 1789—95mm Performance Throttle Body (2010-15 Camaro V8, 06-13 Corvette 7.0, 08-13 Corvette 6.2)
- 1790—102mm Performance Throttle Body (2010-15 Camaro V8, 06-13 Corvette 7.0, 08-13 Corvette 6.2)



POWER-PLUS®

S E R I E S



FORD FOCUS & ECOBOOST THROTTLE BODIES

- + Direct Replacement Power Plus Series Throttle Bodies
- + 30%–35% Better Flow Than Stock
- + Easy Bolt-on 6-12 Horsepower In Minutes

For enthusiasts of Ford's Focus, Mustang & F150 models – our BBK engineers have developed an assortment of our world famous Power Plus Series throttle bodies for this very responsive engine platforms. Each unit is designed as a direct bolt-on and will work with the factory & aftermarket tunes. Aircraft quality construction and dyno proven performance ensure unmatched value. For more information on these and other BBK products please visit www.bbperformance.com

1750—62mm Eclipse/Talon Performance Throttle Body (1994-98 Turbo)
 1751—65mm Focus Performance Throttle Body (2000-01 2.0L Zetec)
 1754—66mm SVT Focus Performance Throttle Body (2002-04)
 1898—65mm Focus ST Performance Throttle Body (2013-15)

50STATELEGAL

EO# D-245-17

FORD F-SERIES 6.2L RAPTOR 85MM PERFORMANCE THROTTLE BODY

- + Includes OEM Style Drive Motor & Electronics
- + Flows 30%–35% More Than Stock
- + Works With Stock Or Aftermarket Tunes
- + 10HP & 8 lb-ft of Torque At The Wheels

See all new intake for Raptor on page 32

Take a look at our All new F-Series 6.2L 85mm Power Plus throttle body that fits all 2010-2014 6.2L Ford F-Series trucks including, Raptor, XLT, Lariat, FX2, FX4 and Platinum edition trucks. This throttle body is a simple 15 minute installation provides Up to 10 horsepower and 8 lb-ft of torque over stock and will work with your stock or aftermarket tune, making it one of the best bang for the buck bolt-ons for your F-Series truck! Add a BBK cold air intake system for even more power and performance Part # 1831 Chrome finish or Part # 18315 Black Out finish. All BBK Performance Power Plus Series throttle bodies are CNC machined from high quality 356 aluminum castings to ensure perfect OEM quality and fit every time. Features like OEM die stamped throttle linkages, double sealed bearings, O ringed throttle shafts and new electronic controlled injection molded plastic gear assemblies for the new modern drive by wire applications, make BBK throttle bodies number one in performance and quality.

1823—2010-14 Ford F-Series Truck 6.2L 85mm Throttle Body

NEW



50STATELEGAL

GA EO# D-245-17

www.bbperformance.com

CONVERTS ELECTRONIC THROTTLE TO CABLE FOR ENGINE SWAPS



GM LS-2 92MM & 100MM

Designed for popular LS1 engine swaps our new 92mm & 100mm performance Throttle bodies offer maximum performance for your project. Built in the USA with a new computer machined casting and top notch components each throttle body is designed as a simple direct bolt-on that can be done in just minutes. Please note these units feature a cable style throttle linkage to ensure an easy integration to your swap application.

1783—92mm Performance Throttle Body (GM LS2/3)
1784—100mm Performance Throttle Body (GM LS2/3)

DODGE HEMI 5.7 / 6.1 / 6.4L 80MM & 87MM

Now available for the popular 5.7L / 6.1L / 6.4L Hemi swaps, our new cable style performance throttle bodies are available in 80mm & 87mm versions to ensure a perfect performance match for your specific project. Featuring all USA made component and a brand new computer machined casting, nothing can match the quality or performance of new BBK units.

1791—80mm Performance Throttle Body (5.7L/6.1L/6.4L HEMI)
1792—87mm Performance Throttle Body (5.7L/6.1L/6.4L HEMI)



THROTTLE BODIES



NEW PRODUCTS ADDED MONTHLY

With expanded equipment & personnel, our R&D team is working at the highest level ever to design & build a record number of high quality BBK performance products for your favorite auto & truck models. In addition to our all new 2015-2016 Mustang products seen in this catalog, look for many new throttle body, air intake and performance exhaust applications to hit the streets in the coming months for such vehicles as the LT1 equipped Camaro & Corvette, Dodge Hemi SRT & Hellcat models. As this new product engineering is happening all the time and Detroit is putting out awesome performance vehicles at a record pace, be sure to check out www.bbkperformance.com or visit our Facebook, Instagram, Twitter or Youtube channels.



FACTORY STYLE THROTTLE POSITION SENSORS (TPS)

Direct fit OE style TPS sensors with factory harness connectors. Fit all Stock OEM Throttle Bodies and All BBK Power Plus Series Throttle Bodies. Available for Ford & GM applications

- 1684—86-93 Ford Mustang 5.0 Throttle Position Sensor
- 1689—94-95 Ford Mustang 5.0 Throttle Position Sensor
- 1685—96-04 Ford Mustang GT Throttle Position Sensor
- 1687—85-92 GM 305/350 TPI Throttle Position Sensor
- 1688—92-04 GM 350 LTI Throttle Position Sensor



HIGH QUALITY REPLACEMENT GASKETS

+ Available for Hundreds of Applications
+ Stamped from High Quality Materials

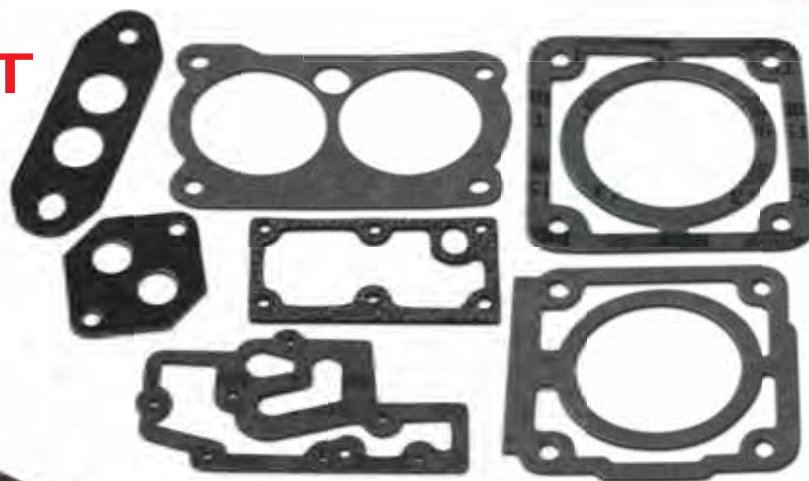

EXHAUST HEADER GASKETS

- 1400—Ford 302/351 1-3/4" Exhaust Header Gaskets
- 1401—Ford 4.6L 2V Exhaust Header Gaskets
- 1402—Ford 4.6L / 5.4L 4V Exhaust Header Gaskets
- 1403—Ford 4.6L 3V Exhaust Header Gaskets
- 1404—GM LS1 4.8/5.3/5.7/6.0/6.2 Exhaust Header Gaskets
- 1405—Hemi 5.7/6.1L Exhaust Header Gaskets
- 1406—GM Small Block Exhaust Header Gaskets
- 1407—Ford 3.8/3.9L V6 Exhaust Header Gaskets
- 1408—Ford 4.0L V6 Exhaust Header Gaskets
- 1409—GM LLT V6 Exhaust Header Gaskets
- 1410—Ford 5.0 Coyote Exhaust Header Gaskets
- 1411—Ford 3.7L V6 Exhaust Header Gaskets
- 1412—Hemi Truck 5.7L Exhaust Header Gaskets
- 1575—Ford SBF/351 1-5/8" Exhaust Header Gaskets
- 1576—GM 305/350 Exhaust Header Gaskets

THROTTLE BODY GASKETS

- 1570—Ford F-Series 87-96 56mm Throttle Body Gasket Kit
- 1572—Ford SBF 65/70mm Throttle Body / EGR Gasket Kit
- 1573—Ford SBF 75mm Throttle Body / EGR Gasket Kit
- 1574—Ford F-Series 87-96 61mm Throttle Body Gasket Kit
- 1578—Honda 62mm Throttle Body Gasket Kit
- 1579—Acura 70mm Throttle Body Gasket Kit
- 1583—GM 305/350 52mm Throttle Body Gasket Kit
- 1584—GM 305/350 58mm Throttle Body Gasket Kit
- 1585—Ford 4.6-2V/5.4 70/75mm Throttle Body Gasket Kit
- 1587—Ford 96-04 4.6L Cobra Twin 62mm Throttle Body Gasket Kit
- 1588—Ford 89-02 66mm Ranger Throttle Body Gasket
- 1589—Ford Lightning / Mustang Cobra Twin 65mm
- 1604—GM LS1/Vortec 80mm Throttle Body Gasket
- 1605—Ford 94-95 Mustang GT (All Sizes) Throttle Body Gasket

INTAKE MANIFOLD GASKETS

- 15062—Ford GT40/Cobra Intake Manifold Plenum Gasket Set (2)
- 15082—Ford Stock 302/351 Intake Manifold Plenum Gasket Set (2)
- 15202—Ford Edelbrock Performer Intake Manifold Plenum Gasket Set (2)
- 15492—Ford TFS Street Heat/Track Intake Manifold Plenum Gasket Set (2)
- 1601—Ford BBK SSI Intake Manifold Plenum Gasket Set (2)

1997-04 GM SSI-SERIES LS1 & LS6 INTAKE MANIFOLD

Designed for the popular LS1 equipped Camaro/Firebird, Corvette and GTO models, our new SSI-Series® performance intake manifold delivers unmatched performance and value when compared to other aftermarket units. By improving over the factory Z06 Corvette intake, our engineers were able to come up with a unit that delivers 12–15 additional rear wheel horsepower on the base LS1 equipped GM models. Such highlights include a standard 85mm straight through design throttle inlet and low restriction rounded runners for maximum horsepower along with improved low end torque for great street or strip performance. For additional power gains and value, we also offer the intake manifold kit with one of our popular Power-Plus® Series performance throttle bodies. This new intake is available standard with a beautiful titanium powdercoat finish. For ease of installation our SSI-Series® manifold utilizes factory rubber o-ring gaskets and includes all mounting hardware for a simple do-it-yourself bolt-on.

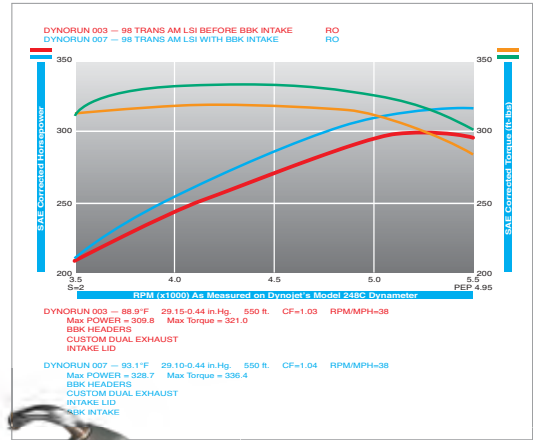

BBK Power Plus series throttle bodies are a perfect match to our GM intake manifolds and deliver additional power without sacrificing mileage and drivability.

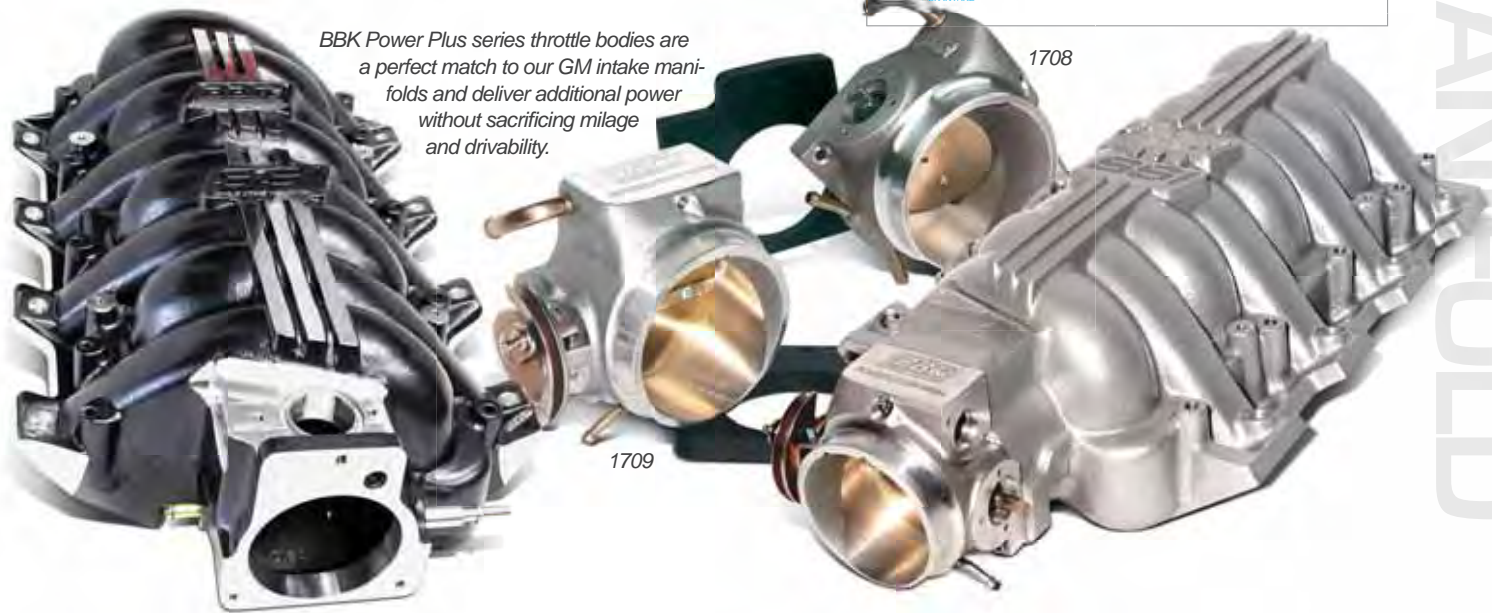

- 5004—SSI-Series Performance LS1/LS6 Intake Manifold (Titanium finish) (1997–04 models)
- 5005—SSI-Series Performance LS1/LS6 Intake Manifold (Titanium finish) with P/N 1709 80mm Throttle Body (Cable Style Throttle Body)
- 5006—SSI-Series Performance LS1/LS6 Intake Manifold (Titanium finish) with P/N 1708 80mm Throttle Body (Electronic Throttle Control)
- 50045—SSI-Series Performance LS1/LS6 Intake Manifold (Blackout finish) (1997–04 models)

PHENOLIC MUSTANG MANIFOLD SPACERS

- + Easy To Install, Includes New Bolts & Gaskets
- + Bolt-On 4–7 Horsepower By Reducing Heat And Increasing Runner Lengths

As one of the most affordable bolt-ons for today's automotive enthusiasts, Phenolic Manifold Spacer Kits have proven to be a great way to increase performance. CNC machined from a custom phenolic fiber material, these spacer kits increase power by dramatically reducing the transfer of heat from lower to upper intake manifold. This in-turn produces lower inlet air temperatures which results in added horsepower and the ability to add more timing advance with less detonation. Phenolic manifold spacers have also become a popular way of increasing manifold to valve cover clearance to accommodate popular bolt-ons such as performance rocker arms and rocker arm covers.

- 1506—Phenolic Manifold Spacer Kit (Cobra and GT-40 Intakes)
- 1508—Phenolic Manifold Spacer Kit (Factory 5.0 Intakes)
- 1520—Phenolic Manifold Spacer Kit (Edelbrock Performer Intakes)
- 1549—Phenolic Manifold Spacer Kit (TFS Intakes)
- 1530—Phenolic Manifold Spacer Kit (BBK SSI/SSI-R)



HIGH-FLOW BILLET ALUMINUM FUEL RAIL SYSTEMS



FORD

HEMI

GM

Built from lightweight CNC machined extruded aircraft quality aluminum, these new high-flow fuel rail systems deliver unmatched performance and are designed as a direct fit with unique mounting hardware, high pressure hoses and precision fittings. Whether your car is near stock or heavily modified with such add-ons as a supercharger, turbo or nitrous, these fuel rail kits will deliver maximum performance and great looks at a very competitive price. Systems are available for Ford 4.62V & 3V, 5.0L, 5.7/6.1L/6HL Hemi and GM LS1 models and are anodized in Ford blue, Hemi orange and GM red respectively. For more information visit www.bbkperformance.com

All rail kits come in sets and include hardware required for easy installation

- 5010—High-Flow Aluminum Fuel Rail Kit (1986–93 5.0L Ford Mustang)
- 5015—High-Flow Aluminum Fuel Rail Kit (1996–98 4.6L Ford Mustang)
- 5016—High-Flow Aluminum Fuel Rail Kit (1999–04 4.6L Ford Mustang)
- 5017—High-Flow Aluminum Fuel Rail Kit (2005–10 4.6L Ford Mustang)
- 5018—High-Flow Aluminum Fuel Rail Kit (1997–04 GM LS1)
- 5019—High-Flow Aluminum Fuel Rail Kit (2005–15 5.7/6.1L/6.4L Hemi)
- 5020—High-Flow Aluminum Fuel Rail Kit (2010–15 Camaro LS3/L99)

OIL SEPARATOR KITS

- + Available For Mustang, F150 & Focus ST
- + Lightweight Billet Aluminum Construction
- + Direct Fit Kits Feature Direct Plug In OEM Quality Connectors

With the design of today's modern fuel injected motors, crankcase oil vapor is sent back through your PCV system and intake resulting in engine sludge and reduced performance. To eliminate this problem and keep your engine performing at optimal levels, our oil separator kits offer a low cost and simple way to pull & catch this engine oil before it enters your intake. Each kit is built from aircraft quality CNC machined aluminum and is anodized to a beautiful titanium grey finish for unmatched looks and quality. Systems are designed to be a direct plug in to your Mustangs current PCV system and come complete with new line and fittings. We also offer a universal kit that will fit most any modern day PCV equipped auto & truck application.

- NEW1895—Oil Separator Kit (2005-2010 Mustang V6)
- NEW18950—Oil Separator Kit (2005-2010 Mustang GT)
- NEW1896—Oil Separator Kit (2011-2016 Mustang V6)
- NEW18960—Oil Separator Kit (2011-2016 Mustang GT / 12-13 Boss)
- NEW1897—Universal Oil Separator Kit





BBK FUEL REGULATOR REBUILD KIT

BBK has introduced a new and improved regulator overhaul kit to work with the BBK 1706 and 1707 Adjustable Fuel Pressure Regulators. This kit will install directly into these BBK regulators regardless of vintage. Includes a new spring and all components necessary and complete instructions are included and can be accomplished in minutes with the regulator off of the vehicle. Common problems associated with a failed unit would be fuel getting into the upper vacuum portion of the regulator and/or visual fuel leakage between the bottom and top housings.

- + Improved diaphragm
- + Direct fit regardless of age of the BBK regulator
- + Complete with new spring and all necessary hardware and instructions
- + Minutes to complete the installation

NEW 1914—Fuel Regulator Rebuilt Kit (For #1706 & #1707 models)

PERFORMANCE THROTTLE BODY SPACERS

- + Computer Machined Lightweight Aluminum
- + Anodized Finish
- + Included New Gaskets if Required

Designed to be a simple and inexpensive power bolt-on, throttle body spacers have been a popular add on in the aftermarket for years. To add more value and usability when designing our own variation of these upgrade items our engineers have also added a built in port that features a

- NEW** 1904—HEMI 5.7L / 6.1L Spacer
- NEW** 1905—GM-LS1 Spacer
- NEW** 1906—GM-LS2/LS3 Spacer
- NEW** 1907—FORD 4.6L 2V Spacer
- NEW** 1910—FORD 5.0L 4V Spacer
- NEW** 1911—FORD 3.7L Spacer

removable plug and can be removed to add a standard size nitrous bar. Starting with solid aluminum plate, each BBK throttle body spacer is fully computer machined with a unique bore designed to maximize intake velocity and flow and is anodized in a trick charcoal/titanium finish for awesome looks whether for a Ford, GM or Dodge model.



BILLET ALUMINUM UNIVERSAL FUEL PRESSURE REGULATOR

- + Adjustable from 40-75 PSI
- + Includes ORB-06 fittings, 2 inlet and 1 return
- + 1/8" NPT gauge port
- + 2 bolt firewall mounting bracket included

BBK has had a long successful history with it's street bolt-on adjustable fuel pressure regulators, we are now expanding that quality line to cover the more custom, higher performance EFI applications. The new universal high flow adjustable regulator allows a custom, remote mounting of the regulator while also allowing for much increased flow for the higher horsepower applications or can be utilized on more mellow street combinations if custom remote mounting is desired.

NEW 1912—Billet Aluminum Universal Adjustable Fuel Regulator Assembly

- + NPT threads for the inlet, outlet and return
- + Mounts either 3 or 2 bolt Ford OEM or any direct replacement adjustable regulator
- + 2 bolt firewall mounting bracket included

BBK has created a simple and low cost effective solution to remote mounting of your factory or rail mounted adjustable regulators for all '86-98 Mustang applications as well as any Ford application with similar rail mounted regulators. This high quality billet aluminum remote mount housing allows both the 3 bolt and 2 bolt Ford regulator designs to bolt up on the same unit.

NEW 1913—Billet Aluminum Regulator Remote Mount



FORD ADJUSTABLE FUEL REGULATORS

Our adjustable fuel pressure regulators have been a top choice with Ford enthusiasts for many years delivering unmatched value and quality. Available for both the 4.6L & 5.0L models each unit is built to aircraft quality standards with fully CNC machined billet aluminum main body assembly finished in a beautiful blue anodized finish along with a high performance diaphragm assembly. These units are great for maximizing performance on everything from a stock motor to higher output applications, including the supercharged 4.6L Cobra models. They are an easy do-it-yourself replacement for your factory non adjustable regulator and tuning pressure can be done in seconds on the car. We do recommend a fuel pressure gauge such our part #1617 liquid filled model show on this page as it mounts to our adjustable regulators eliminating running fuel pressure into your interior.



- 1706—Billet Adjustable Fuel Pressure Regulator (1986–93 5.0L Mustang)
- 1707—Billet Adjustable Fuel Pressure Regulator (1990–97 4.6L 2V, 1994–98 4.6L 4V, 1994–95 5.0L)



GM TPI 305 / 350 ADJUSTABLE FUEL REGULATOR KIT

Owners of GM's popular 1985–92 305/350 TPI equipped vehicles can get maximum performance along with precise air/fuel ratios with this trick and easy to install billet aluminum adjustable fuel regulator kit. Designed as a direct replacement for your non adjustable factory unit, this part is built from aircraft quality CNC machined billet aluminum along with high quality hardware. In order to ensure a simple and hassle free installation we also supply new OEM style plenum / runner gaskets.

- 1714—Billet Adjustable Fuel Pressure Regulator Kit (1985–92 GM 305/350 TPI Camaro / Firebird / Corvette)

LIQUID FILLED FUEL PRESSURE GAUGE

Designed to mount directly to our popular part #1706/1707/1912 Ford adjustable fuel pressure regulators or to a universal application for engine compartment locating, this liquid filled fuel pressure gauge offers safe and easy tuning of your air/fuel ratios. Built with liquid filled main body to handle the intense vibration and heat of your motor, this gauge indicated up to 60PSI to handle most any application.

- 1617—Liquid Filled Fuel Pressure Gauge (0-60PSI)





HIGH-VOLUME OEM STYLE ELECTRIC FUEL PUMP KITS 1986-97 MUSTANG

- + Available for Dodge, Ford, GM, Jeep & Subaru Models
- + OEM design for easy install without modifications
- + High Flow design delivers more volume & pressure when needed
- + Works great on stock or with other performance modifications

Since 1988 BBK high-volume fuel pump kits have been a top choice with late model auto & light truck enthusiasts. Designed as a direct replacement for the factory electric fuel pump, each system is designed to provide up to 50% more volume than a factory pump when needed, however like the stock pump the BBK pumps will work great on stock applications as with fuel injected models your vehicle will regulate the amount of fuel needed depended on load. With the BBK high volume pumps you car or truck will have that reserve volume needed especially when used in conjunction with other popular performance upgrades.

VEHICLE APPLICATION GUIDE

MAKE	MODEL	YEAR RANGE	FLOW	PUMP KIT PART #
Dodge	Dakota	1996-2004	255LPH	1868
Dodge	Ram	1995-2004	255LPH	1868
Dodge	Neon / Inc. Turbo	1995-2004	255LPH	1870
Ford	F150	1997-1998	255LPH	1871
Ford	F150	1999-2004	255LPH	1872
Ford	Lightning	1999-2004	255LPH	1873
Ford	Mustang V8	1987-1997	110LPH	1526
Ford	Mustang V8	1986-1997	155LPH	1527
Ford	Mustang V8	1986-1997	190LPH	1606
Ford	Mustang V8	1986-1997	255LPH	1607
Ford	Mustang Cobra	1996-1997	255LPH	1622
GM	Grand National	1984-1986	255LPH	1874
GM	Camaro / Firebird / Corvette	1985-1992	255LPH	1630
GM	Chevrolet S10	1985-1995	255LPH	1874
Honda	Civic	1992-2000	190LPH	1876
Honda	Civic	1992-2000	255LPH	1621
Jeep	Wrangler	1997-2004	190LPH	1877
Jeep	Wrangler	1997-2004	255LPH	1878
Jeep	Cherokee	1997-2001	190LPH	1877
Jeep	Cherokee	1997-2001	255LPH	1878
Subaru	Impreza WRX	2002-2006	255LPH	1881

(Up to 550HP)

HIGH VOLUME VARIABLE FLOW FUEL PUMP SYSTEMS

1998-2004 FORD MUSTANG V6, GT & COBRA

- + Direct Replacement Or An Upgrade To Your Existing Fuel Pump To Provide More Fuel For Modified Applications
- + Variable Flow Rate That Flows Up To 300LPH / 79 Gallons Per Hour Fuel Pump
- + Will Support High Horsepower But Still Allows For Great Drivability, Making It Equally At Home In Stock Or Highly Modified Applications

1861—1998 Mustang V6, GT & Cobra 300LPH Fuel Pump
1862—1999-2000 Mustang V6, GT & Cobra 300LPH Fuel Pump
1863—2001-2004 Mustang V6, GT & 2001-2002 Cobra 300LPH Fuel Pump

2005-2010 FORD MUSTANG V6 & GT

- + Direct Replacement Or An Upgrade To Your Existing Fuel Pump To Provide More Fuel For Modified Applications
- + Variable Flow Rate That Flows up to 300LPH / 79 Gallons Per Hour Fuel Pump
- + Will Support High Horsepower But Still Allows For Great Drivability, Making It Equally At Home In Stock Or Highly Modified Applications

1865—2005 Mustang V6, GT 300LPH High Volume Fuel Pump
1866—2006-2009 Mustang V6, GT 300LPH High Volume Fuel Pump
1867—2010 Mustang V6, GT 300LPH High Volume Fuel Pump
1526—110 LPH Fuel Pump Kit (1986-97 Mustang V8)
1527—155 LPH Fuel Pump Kit (1986-97 Mustang V8)
1606—190 LPH Fuel Pump Kit (1986-97 Mustang V8)

2004-2008 FORD F150 4.6/5.4

- + Direct Replacement In-tank Electric Fuel Pump To Fit All Standard Range 27 Gallon Applications
- + Variable Flow Rate Up To 300LPH Or 79 Gallons Per Hour
- + For Stock Or Modified Applications

1864—2004-2008 Ford F150 4.6L/5.4L 300LPH Fuel Pump (Standard Range 27 Gal Tank)



BBK HIGH-VOLUME FUEL PUMPS OFFER A SIMPLE INSTALL

Since 1988 BBK has been delivering a line of high volume direct replacement pump kits for the do it yourself enthusiasts. Our engineers have spent countless hours working to ensure each BBK performance pump kit comes complete with the needed hardware so installations are straightforward and easy to perform. To make things even easier our marketing team has been producing a number of BBK fuel pump installs which can be found on our website at www.bbkperformance.com as well as our BBK YouTube Channel.



W W W . B B K P E R F O R M A N C E . C O M

www.bbkperformance.com

1986-04 MUSTANG HIGH-FLOW MASS AIR METERS

- + All New CNC Machined Aluminum Casting
- + Bolt-On 8-12 Horsepower In Minutes
- + Available For Most Injector Sizes
- + Includes New Electronics

BBK, well known as the #1 EFI Source, has finally brought to you an awesome new mass air sensor line covering all the popular Ford applications. These beautiful units are CNC machined from aircraft quality aluminum castings featuring a beautiful charcoal metallic Powder Coating and come complete with full electronically calibrated sensors. They are available in all the popular configurations for cold air intakes and various injector sizes.

- 8002—Mass Air 76mm 19# CAC (1986-93 GT/LX)
- 8003—Mass Air 76mm 24# FAB (1986-93 GT/LX)
- 8004—Mass Air 76mm 24# CAC (1986-93 GT/LX)
- 8005—Mass Air 76mm 30# CAC (1986-93 GT/LX)
- 8007—Mass Air 76mm 19# CAC (1994-95 GT/LX)
- 8009—Mass Air 76mm 24# CAC (1994-95 GT/LX)
- 8010—Mass Air 76mm 30# CAC (1994-95 GT/LX)
- 8012—Mass Air 86mm 19# CAC (1996-98 GT 4.6L-2V)
- 8014—Mass Air 86mm 24# CAC (1996-98 GT 4.6L-2V)
- 8017—Mass Air 86mm 19# CAC (1999-02 GT 4.6L-2V)
- 8019—Mass Air 86mm 24# CAC (1999-02 GT 4.6L-2V)



BILLET ALUMINUM 76MM VERSION

- + Billet CNC Machined Billet Aluminum Body
- + Machined Finish
- + Bolt-On 8-12 Horsepower
- + Includes New Electronics

With the popularity of our Mustang performance mass air meters released a few years back our team has received additional demand for a similar unit with more of a show finish to add a bit more bling factor while keeping a strong value. To accomplish this feat our engineers designed these new units which are built from aircraft quality billet aluminum which is computer machined and then polished to a beautiful finish and fitted with brand new electronics in a variety of injector calibrations.

- 80025—Mass Air 76mm 19# CAC (1986-93 GT/LX)
- 80045—Mass Air 76mm 24# CAC (1986-93 GT/LX)
- 80055—Mass Air 76mm 30# CAC (1986-93 GT/LX)
- 80075—Mass Air 76mm 19# CAC (1994-95 GT/LX)
- 80095—Mass Air 76mm 24# CAC (1994-95 GT/LX)
- 80105—Mass Air 76mm 30# CAC (1994-95 GT/LX)

CHOOSING THE RIGHT MASS AIR METER

When choosing the proper BBK performance mass air meter for your Ford Mustang, it is important to understand some simple facts in regards to ensuring you pick the right application for your specific project and understand what is needed if future performance upgrades are performed.

First, each BBK mass air meter features brand new custom calibrated electronics that are based on vehicle year, injector size and whether you are using a factory air box (FAB) or an aftermarket air intake (CAC) such as one of our popular Mustang air intake systems. In regards to the air intake portion, these air intake kits represent one of the cheapest and most popular performance gains, therefore we recommend you do this prior to purchasing a new mass air meter. This will not only improve the overall performance of the two items as they compliment each other, but will also save you from the future expense of buying a new mass air meter down the road. With the factory computer being as sensitive as it is, running a FAB (factory air box calibration) on a Mustang equipped with an aftermarket air intake can result in a rough idle.

Second, in regards to injector sizes again it is recommended you first decide and upgrade injectors prior to a mass air meter purchase as it is extremely important to run the proper injector calibration. As an example, a 24 lb injector will inject 25% more fuel into each cylinder than a 19 lb injector which means without the correct mass air calibration your Mustang would run extremely rich resulting in convertor damage and additional problems. Running a mass air that is calibrated for larger injectors with the stock injectors will result in a serious lean condition and a good chance of serious engine damage.

Finally, year is important as each BBK performance mass air meter features a brand new CNC machined aluminum housing which is designed to properly fit each specific year range. As always, should you have any questions please contact one of our technicians at tech@bbkperformance.com or visit our website and YouTube channel for more information and detailed product videos.

AIR INTAKE SYSTEMS

*THE ORIGINATOR OF
THE MODERN DAY
AIR INTAKE SYSTEMS*

Back in the eighties, Brothers Brian & Ken Murphy had started BBK with the goal of designing and building high quality bolt-on performance products for the then new fuel injected

musclecars. This was at a time when enthusiasts were just learning how these latest models from Detroit worked and what could be done to improve performance while still being able to maintain drivability. One of the first BBK creations, new to the aftermarket at the time was the BBK "Cold Air Induction System." That's right, back then companies had just started offering performance replacement flat filters but it was BBK that started designing & building the first modern day air intake system for the 1986 Mustang 5.0L. In fact some of these early Fox



Part # 1100 Restart Kit



Body Mustang systems are still some of BBK's top selling models.

Almost thirty years later, air intake systems are a must have with today's enthusiasts & our BBK air intake systems lead the pack with unmatched dyno proven performance & quality. While air intake systems can be found for most models in this catalog, be sure to visit www.bbkperformance.com for our latest offerings as new systems are introduced almost monthly.

5.7L / 6.1L / 6.4L CHALLENGER, CHARGER, MAGNUM & 300

- + New For 6.4L Challenger
- + Bolt-On Up To 21 Horsepower At The Wheels
- + Chrome & Blackout Finishes Available



Owners of the latest generation of Hemi V8's (Charger, Magnum & 300) can add Up To 21HP with one of our latest cold air induction systems. Designed to be a simple bolt-on system, this kit comes with a new high-flow intake elbow, conical performance filter and a custom shroud for maximum performance. As with all BBK cold-air induction systems, the conical filter is a washable cotton element unit that will last the lifetime of your vehicle. This system features a show quality polished & chrome plated inlet with a black powder finished shroud for excellent looks.

- 1738—Performance Air Intake System (2005-2016 5.7L, 2008-2010 6.1L) – Chrome
- 17385—Performance Air Intake System (2005-2016 5.7L, 2008-2010 6.1L) – Blackout Series
- 1777—Performance Air Intake System (2011-2016 6.4L Models) – Chrome
- 17775—Performance Air Intake System (2011-2016 6.4L Models) – Blackout Series
- 1778—Performance Air Intake System (2005-2010 V6 Models) – Chrome
- 1100—BBK Restore Air Filter Cleaner & Oil Kit (Blue spray oil)

5.7L HEMI RAM SYSTEM

Owners of the popular 5.7L Hemi Ram can also enjoy the easy bolt-on performance of our popular air intake systems which are designed to work with the factory or aftermarket tune. You can expect 12-14 horsepower along with nothing but the best quality American made construction.

- 1733—Performance Air Intake System (2003-2008 5.7L Ram Models) – Chrome
- 1832—Performance Air Intake System (2009-2016 5.7L Ram Models) – Chrome
- 1100—BBK Restore Air Filter Cleaner & Oil Kit (Blue spray oil)



DODGE AIR INTAKE SYSTEMS

THE #1 MUSTANG
AIR INTAKE
KITS FOR OVER
25 YEARS

50STATELEGAL

EO# D-245-14

*Shown with
BBK Mass Air Meter

1986-93 5.0L MUSTANG

+ Beautiful Polished & Chrome Plated Inlet Tubes
+ Lifetime Washable Cotton Element High-Flow Filter

- 1556—Performance Air Intake System / open style (1986–93 5.0L Mustang)—Chrome
- 1557—Performance Air Intake System / fender well style (1986–93 5.0L Mustang)—Chrome
- 15575—Performance Air Intake System / fender well style (1986–93 5.0L Mustang) —Blackout Series Finish
- 1558—Non Mass Air Adapter for 1986–88 models (fits with #1556/1557 systems)—Chrome
- 1100—BBK Restore Kit—Air Filter Cleaner & Blue Re-Oil Kit

*Mass Air Meters not included as shown



With their dyno proven performance gains and unmatched top notch quality, these Fox body Mustang air intake systems were not only the first of their kind back when they originally debuted in the late eighties. Now they are the number one Mustang system on the market with tens of thousands of happy enthusiasts who can attest to their great looks and easy bolt-on performance gains. As the top selling kit on the market there are now a few knock off China built systems in the aftermarket, but a comparison of the two makes it clear what American quality really stands for.

1994-95 MUSTANG GT

Utilizing the same high quality performance features as our 1986-93 systems, this fender well style system for the 1994-95 GT models performs as great as it looks. Top notch features include polished and chrome plated inlet tubes, high breathing washable conical air filter and easy to mount included hardware that will ensure years of long lasting performance as these systems are designed to last the life of your vehicle.

- 1712—Performance Air Intake System / (1994–95 Mustang GT)—Chrome
- 17125—Performance Air Intake System / (1994–95 Mustang GT)—Blackout Series
- 1100—BBK Restore Kit—Air Filter Cleaner & Blue Re-Oil Kit

EO# D-245-14 50STATELEGAL



Blackout Kit Shown



*Shown with BBK Mass Air Meter

50STATELEGAL

EO# D-245-14

1996-04 MUSTANG 4.6L GT

- + Top Selling Mustang System In The Aftermarket
- + Bolt-On 12-18 Horsepower
- + Beautiful Polished Chrome Finish

As the most sought after 4.6L 2V air intake system on the market, our popular 1996-04 Mustang GT system has been number one with Mustang enthusiasts since it was originally introduced in 1994. With it's American engineered quality and performance there have been many low quality China copies, but none have proven to stop the popularity or proven American performance and value this system delivers to Mustang owners.

- 1718—Performance Air Intake System (1996-04 Mustang GT) – Chrome
 - 17185—Performance Air Intake System (1996-04 Mustang GT) – Blackout Series
 - 1100—BBK Restore Kit—Air Filter Cleaner & Blue Re-Oil Kit
- Mass Air Meters not included as shown*

1994-98 MUSTANG 3.8L V6

- + Bolt-On 7-10 Horsepower
- + Easy To Install System
- + Beautiful Polished Chrome Finish

50STATELEGAL

EO# D-245-14



Engineered to deliver a 7-10 horsepower increase over stock, our air intake systems for 1994-98 3.8L V6 models have become a top add on with the growing V6 market. Each system is built right here in the USA and is designed with maximum performance and longevity in mind. Like all our performance air intake systems this also comes complete with any necessary hardware for a simple do it yourself bolt-on experience.

- 1717—Performance Air Intake System (1994-98 3.8L Mustang V6) – Chrome
- 1100—BBK Restore Kit—Air Filter Cleaner & Blue Re-Oil Kit

1999-04 3.8L/3.9L V6 MUSTANG

- + Top Selling 3.8L V6 Kit In The Aftermarket
- + Bolt-On 7-10 Horsepower
- + Lifetime Washable Cotton Element High-Flow Conical Filter

Like it's 1994-98 sibling, this performance air intake system for 1999-04 3.8L V6 Mustang models has continued to grow each year in popularity as more enthusiasts embrace the economy and performance value of the V6 models. Delivering a dyno proven 7-10 horsepower and top notch American engineering and quality, it's easy to see why so many Mustang enthusiasts have picked this performance upgrade for there favorite ride.



50STATELEGAL

EO# D-245-14

- 1719—Performance Air Intake System (1999-04 Mustang 3.8L/3.9L V6) – Chrome
- 17195—Performance Air Intake System (1999-04 Mustang 3.8L/3.9L V6) – Blackout Series
- 1100—BBK Restore Kit—Air Filter Cleaner & Blue Re-Oil Kit

2005–2009 MUSTANG GT

1736—Performance Air Intake System (2005-09 Mustang GT)—Titanium Finish
 17365—Performance Air Intake System (2005-09 Mustang GT)—Charcoal Finish
 17360—Performance Air Intake System (2005-09 Mustang GT)—Polished Finish
 17361—Performance Air Intake System (2005-09 Mustang GT)—Black Plastic
 1100—BBK Restore Kit—Air Filter Cleaner & Blue Re-Oil Kit

When Ford first introduced there all new and hugely popular Mustang redesign with the retro looking 2005 model, companies came out of the woodwork with air intake kits that required an expensive tuner or wouldn't properly operate. Spending months on development our engineering team set out to design a system that would not only out perform all other but would do so with the factory tune or an aftermarket tuner making it the true performance bargain with Mustang enthusiasts. The rest is history as this unique system with features a one piece lightweight aluminum inlet which has a new high flow mass air meter housing built into it's opening, quickly became the top choice with Mustang enthusiasts. In addition to the trick aluminum inlet which is available in titanium, charcoal or polished finishes to match the look of almost any Mustang build, this system includes only the best components and washable high flow conical air filter. This system delivers a dyno proven whopping 14-17 horsepower to the wheels with the factory tune and can be installed in under thirty minutes.



2010 MUSTANG GT SYSTEM

1773—Cold Air Induction (2010 Mustang GT 4.6L) – Polished Chrome
 1100—BBK Restore Kit—Air Filter Cleaner & Blue Re-Oil Kit

50STATELEGAL

EO# D-245-14

Note 2005 - Pre May 2006 Only

CARING FOR YOUR LIFETIME BBK PERFORMANCE CONICAL FILTER

All of our BBK "Power Plus Series" air intake systems are equipped with one of our high flow fully washable cotton element conical air filters. The BBK blue that appears as the filter color is actually the color of the oil that each filter is factory coated with during production. By following some simple easy to do it yourself steps, your BBK conical filter can be cleaned as needed and should last as long as you own your vehicle. Keeping your filter properly cleaned will ensure your vehicle delivers optimum horsepower & mileage. Our part # 1100 Restore Kit features the proper pray cleaner & oil to wash and re coat your BBK filter using the following steps. Be sure to visit our site at www.bbperformance.com for a video on how to clean your BBK air filter along with hundreds of other great how-to and performance videos.

1. Remove your BBK conical air filter from your vehicle
2. Spray the ribbed outside portion of the filter with your BBK spray cleaner
3. Using warm water with very little pressure, simply wash the filter from the inside which will remove the miles of dust etc that has collected.
4. After cleaning to a desired level simple let the filter air dry fully and now your ready to spray from the outside of the filter your new BBK oil and the filter is ready for use.
5. We recommend cleaning every 5,000 miles, however it really depends on the level of dust & dirt that's has accumulated so it's a great idea to check your air filter status at each oil change interval.



2011-14 MUSTANG V6 & V8

- + Bolt-On Up To 20 Horsepower
- + Works With Stock Or Aftermarket Tuners

With the re-introduction of Fords famous 5.0L in 2011, our engineers have been busier than ever developing a wide range of our famous performance products for this new offering as well as it's over 300HP V6 sibling. After all it was the first 5.0L Mustang back in 1986 that launched BBK and the hundreds of products that have followed in the years ever since. Starting with one of our best performance bolt-on values our team designed these awesome new performance air intake systems for both the 3.7L & 5.0L models. As with any BBK air intake system, you can expect an American built high quality system that will bolt-on in minutes and work with your stock or after market tune.



- 1768—Performance Air Intake System / (2011-14 Mustang 5.0L)—Chrome
- 17685—Performance Air Intake System / (2011-14 Mustang 5.0L)—Blackout Series
- 1778—Performance Air Intake System / (2011-14 Mustang 3.7L V6)—Chrome
- 17785—Performance Air Intake System / (2011-14 Mustang 3.7L V6)—Blackout Series
- 1100—BBK Restore Kit—Air Filter Cleaner & Blue Re-Oil Kit

5.0L V8

NEW



3.7L V6

SEE ONLINE VIDEO

1996-04 MUSTANG COBRA 4.6L 4V

To get the best performance and overall fitment and looks, our engineers designed a trick one piece aluminum inlet for these Mustang Cobra kits. Available for 1996-04 Cobra models each system is a statement of American engineering and manufacturing with all top notch quality components including a washable high flow conical air filter for maximum performance. Extensive dyno testing during development ensures gains of 12-16 horsepower with the factory tune, however they will also work with aftermarket tuners and are designed to install in less than an hour.

- 1713—Performance Air Intake System (1996-98 Mustang Cobra & Bullitt Models)
- 17130—Performance Air Intake System (1999-02 Mustang Cobra)
- 1725—Performance Air Intake System (2003-04 Mustang Cobra)
- 1100—BBK Restore Kit—Air Filter Cleaner & Blue Re-Oil Kit

EO# D-245-14

50 STATE LEGAL



FORD AIR INTAKE SYSTEMS

2005–2010 MUSTANG V6

+ Top Selling 2005–10 V6 System On The Market
+ Proudly Made In The USA

With its beautiful polished and chrome plated finish, high quality custom molded silicon house, stainless steel clamps and complete easy to install design, our performance air intake system for 2005-10 V6 owners delivers the goods. With dyno proven 8-12 horsepower gains and a design that will allow this system to work with your factory or an aftermarket tune. This air intake kit is a great addition to your 2005-10 Mustang V6 and is the top seller in this category.

- *1737—Performance Air Intake System (2005-10 Mustang V6) – Chrome
- *17375—Performance Air Intake System (2005-10 Mustang V6) – Blackout Series
- *1100—BBK Restore Kit – Air Filter Cleaner & Blue Re-Oil Kit

50STATELEGAL

EO# D-245-14

2015-2016 MUSTANG AIR INTAKE SYSTEMS

- + ECOBOOST + V6 + GT
- + Bolt-On Up To 18 RWHP
- + Available In Hand Polished Chrome Or Black At Series
- + Works With Stock Of Aftermarket Tune

As the first company to bring design & bring to the aftermarket a Mustang Cold Air Intake System back in the late 1980's, it's no surprise that our engineers released a full line of systems for all engine models for the latest generation 2015-2016 Mustang. Designed to deliver a dyno proven 12-18 rear wheel horsepower with the factory tune and even more when equipped with a custom tune, our Air Intake Systems will deliver unmatched performance, value and looks for your Mustang. As with our top selling systems for the earlier models, each of these new kits is available in with our custom hand polished chrome or Blackout Series high flow inlet, extra high flowing washable cotton element conical air filter and a custom powder coated filter housing. Each system also features custom molded silicone connector hoses to ensure maximum quality and our GT system even features a custom molded plastic vacuum house tree to re-route the messy stock hoses in a super clean layout. Be sure to visit www.bbkperformance.com for detailed product videos, dyno information and other awesome BBK products for your 2015-2016 Mustang.

- NEW**1850—Performance Air Intake System (2015-2016 Mustang Ecoboost) – Chrome
- NEW**18505—Performance Air Intake System (2015-2016 Mustang Ecoboost) – Blackout Series
- NEW**1846—Performance Air Intake System (2015-2016 Mustang V6) – Chrome
- NEW**18465—Performance Air Intake System (2015-2016 Mustang V6) – Blackout Series
- NEW**1847—Performance Air Intake System (2015-2016 Mustang GT) – Chrome
- NEW**18475—Performance Air Intake System (2015-2016 Mustang GT) – Blackout Series



F-SERIES / EXPEDITION / RAPTOR

Add 8-10 horsepower, all American built construction and a beautiful show quality polished chrome finish. What else could you possibly desire when looking to enhance the power and towing performance of your 1997-03 Ford F-Series/Expedition truck. Not to mention that you can install this new performance air intake system yourself in less than an hour with basic hand tools. Please note, this system is compatible with factory or aftermarket tuners and works great with other power enhancements such as our power plus series throttle body and high flow direct fit tuned length headers.

50STATELEGAL

EO# D-245-14



- 1720—Performance Air Intake System (1997-03 Ford 4.6L/5.4L F-Series & Expedition)
- *1744—Performance Air Intake System (2004-08 Ford F-Series & Expedition 5.4L)

The same performance and quality features of our 1997-03 Ford truck air intakes is available now for owner of the 2004-11 F-Series/Expedition models as well. With gains of 8-10 horsepower and unmatched quality and looks this system makes a great performance upgrade.

50STATELEGAL

EO# PENDING

See Website For Update



- 1830—Performance Air Intake System (2007–11 Ford 5.4 F-Series / 04–06 Ford 5.4L Expedition)
- 1831—Performance Air Intake System (2010–14 Ford 6.2 F-Series/Raptor)—Chrome
- 18315—Performance Air Intake System (2010–14 Ford 6.2 F-Series/Raptor) —Blackout Series
- 1100—BBK Restore Kit—Air Filter Cleaner & Blue Re-Oil Kit



1999-02 FORD LIGHTNING SYSTEM

A custom lightweight aluminum inlet casting helps to make this performance air intake for 1999-02 5.4L Lightning models a proven performer with gains of up to 18 horsepower and a complete easy to install design.

- 1734—Performance Air Intake System (1999–02 Ford 5.4L Lightning Truck)—Polished
- 1100—BBK Restore Kit—Air Filter Cleaner & Blue Re-Oil Kit



50STATELEGAL

EO# D-245-14

FORD AIR INTAKE SYSTEMS

GM AIR INTAKE SYSTEMS



VIDEO SEE ONLINE VIDEO



2010-15 CAMARO SS

- + Bolt-On 12-18 Horsepower In Minutes
- + Beautiful Polished Chrome Finish
- + Works With Stock Or Aftermarket Tuners

With its huge 3.5" high flow inlet, our new performance air intake system for the hot new 2010-15 Camaro SS delivers an unbelievable dose of American innovation and quality. Extensive dyno testing has shown consistent gains of up to 18 horsepower with the factory tune and even more with aftermarket tunes. Other features include a billet aluminum mass air sensor mount, custom molded silicon hoses, stainless steel clamps a high quality shroud assembly and a high flowing washable conical air filter.

- 1771—Performance Air Intake System (2010-15 Camaro SS) — Chrome
- 17715—Performance Air Intake System (2010-15 Camaro SS) — Blackout Series
- 1100—BBK Restore Kit—Air Filter Cleaner & Blue Re-Oil Kit

EO# PENDING 50STATELEGAL
See Website For Update

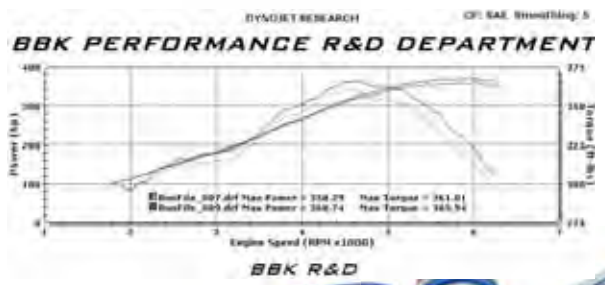

VIDEO SEE ONLINE VIDEO

2010-15 CAMARO V6 RS

- + Bolt-On 8-12 Horsepower In Minutes
- + Beautiful Polished Chrome Finish
- + Works With Stock Or Aftermarket Tuners

Delivering 8-12 horsepower along with all the high quality features of our SS systems, this new performance air intake kit for 2010-15 Camaro RS is unmatched. Like all BBK air intake systems this model is designed to work your stock or an aftermarket tune and can be installed in under an hour with basic hand tools.

- 1772—Performance Air Intake System (2010-11 Camaro RS)—Chrome
- 17725—Performance Air Intake System (2010-11 Camaro RS)—Blackout Series
- 1835—Performance Air Intake System (2012-15 Camaro RS)—Chrome
- 18355—Performance Air Intake System (2012-15 Camaro RS)—Blackout Series
- 1100—BBK Restore Kit—Air Filter Cleaner & Blue Re-Oil Kit

50STATELEGAL
EO# PENDING
See Website For Update

1997-2013 C5/C6 CORVETTE

- + Trick Lightweight Aluminum Inlet
- + Titanium Powder Coat Finish
- + Bolt-On 14-20 Horsepower In Minutes

Instead of mimicking the other Corvette cold-air systems that feature a plastic inlet plenum, our engineers came up with a unique and beautiful lightweight powder coat aircraft aluminum plenum that delivers the same bolt-on power increase with much improved quality and underhood looks for your favorite Corvette. Each BBK "Cold Air Induction" system comes with this all new aluminum plenum, a large high-flow cotton element conical filter and high quality mounting hardware for an installation that can be performed in just minutes for an easy 14-20 horsepower and improved induction sound. This system is also available in a beautiful show polished version for the ultimate in great looks. For more information visit www.bbkperformance.com

- *1726—Aluminum Cold-Air Induction C5 (1997-04) – Titanium
- *1735—Aluminum Cold-Air Induction C6 (2005-07) – Titanium
- *1749—Aluminum Cold-Air Induction C6 (2006-13 LS7 Corvette Z06 / Sport Corvette) – Titanium Silver Powder coat
- 1100—BBK Restore Kit – Air Filter Cleaner & Blue Re-Oil Kit



50STATELEGAL

EO# D-245-14

1999-2013 GM FULL SIZE TRUCK AIR INTAKE SYSTEMS



BBK has covered a large grouping of the very popular GM full size trucks and SUV's with just 2 parts numbers! These kits are complete for a direct bolt-on installation in very little time. Included are custom molded couplers and clamps along with the BBK hi flow washable conical filter elements and the tough and attractive aluminum or steel inlet tubes and metal powder coated air filter shroud for long term durability, looks and performance. These kits add a noticeable torque and horsepower increase and will never require a new filter again.

- 17295—1999-2002 GM Full Size Truck and SUV – Blackout Series
- 1839—2003-2013 GM Full Size Truck and SUV – Chrome
- 18395—2003-2013 GM Full Size Truck and SUV – Blackout Series



GM AIR INTAKE SYSTEMS

SEE ONLINE VIDEO

GENERAL MOTORS

FORD

DODGE

BBK REPLACEMENT HIGH FLOW COTTON ELEMENT FILTERS FOR BBK KITS

These cotton element high flow conical air filters are the same ones found in our various air intake systems and deliver unmatched value and performance as a direct replacement or for custom applications. Each filter is designed to flow up to 75% better than stock paper element filters and the cotton fiber filtering material is fully washable for years of great performance. Please note – dimensions are listed below for replacement matching or for custom applications.

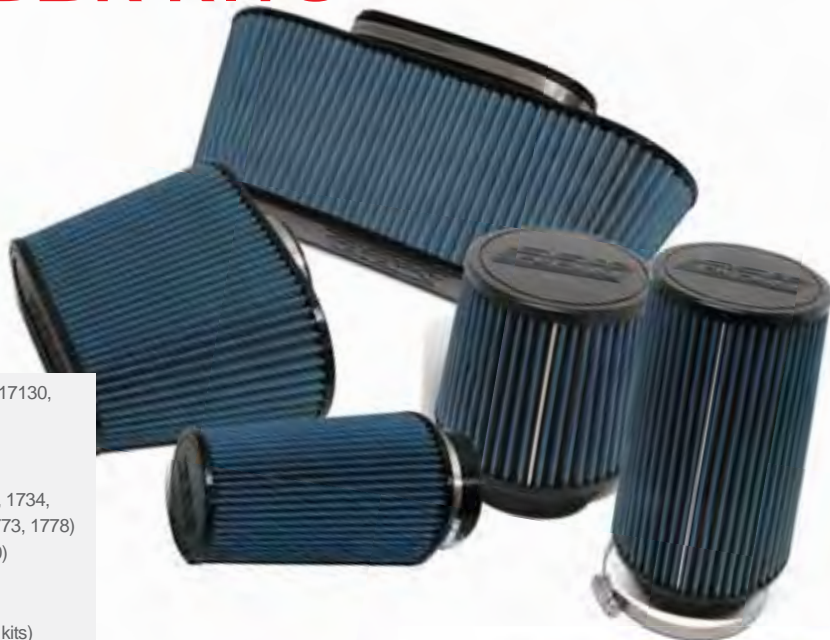

- 1740—Performance Cotton Element Conical Air Filter (fits BBK 1713, 17130, 1717, 1718, 17185, 1719, 1725, 1735, 1785 kits)
- 1741—Performance Cotton Element Conical Air Filter (fits 1557, 15575, 1712, 1775 kits)
- 1742—Performance Cotton Element Conical Air Filter (fits 1556, 1720, 1734, 1736, 17360, 17365, 1737, 17375, 1742, 1744, 1748, 1772, 1773, 1778)
- 1746—Performance Cotton Element Conical Air Filter (fits 1726, 17260)
- 1788—Performance Cotton Element Conical Air Filter (fits 1733, 1738)
- 1774—Performance Cotton Element Conical Air Filter (fits 1771)
- 1840—Performance Cotton Element Conical Air Filter (fits 1747, 1768 kits)
- 1100—BBK Restore Kit Air Filter Cleaner & Re-Oil Kit (Blue, for all BBK filters)

BBK PERFORMANCE AIR FILTER RESTORE KIT

Works for all BBK performance filters included with all BBK Cold air induction kits. Restore air flow and put performance back into your air filter. Simply apply the cleaner solution to dissolve dirt and grime build up and rinse with cold water. Allow the filter to air dry and then apply the new BBK oil to refresh and revitalize your air filter.



- 1100—BBK Restore Kit—Air Filter Cleaner & Blue Re-Oil Kit

BBK COLD AIR INTAKE REPLACEMENT HARDWARE & HOSE KITS

Replace your old dirty or split hoses and hardware with brand new original BBK kit parts. These cold air hardware kits include all the hoses and all the hardware included with your original kit. New BBK blue

- 15562—86-93 Mustang 5.0 CAI Hardware Kit (1556* Kits)
- 15572—86-93 Mustang 5.0 CAI Hardware Kit (1557* Kits)
- 17122—94-95 Mustang 5.0 CAI Hardware Kit (1712* Kits)
- 17172—94-98 Mustang V6 CAI Hardware Kit (1717* Kits)
- 17182—96-04 Mustang GT CAI Hardware Kit (1718* Kits)
- 17192—99-04 Mustang V6 CAI Hardware Kit (1719* Kits)
- 17262—97-04 Corvette CAI Hardware Kit (1726* Kits)
- 17352—05-07 Corvette CAI Hardware Kit (1735* Kits)
- 17362—05-09 Mustang GT CAI Hardware Kit (1736* Kits)
- 17372—05-10 Mustang V6 CAI Hardware Kit (1737* Kits)
- 17382—05-12 Hemi CAI Hardware Kit (1738* Kits)
- 17682—11-14 Mustang GT CAI Hardware Kit (1768* Kits)
- 17712—10-14 Camaro SS CAI Hardware Kit (1771* Kits)
- 17722—10-11 Camaro V6 CAI Hardware Kit (1772* Kits)
- 18352—12-14 Camaro V6 CAI Hardware Kit (1835* Kits)
- 17782—11-14 Mustang V6 CAI Hardware Kit (1778* Kits)
- 17852—05-10 Dodge 3.5L V6 CAI Hardware Kit (1778* Kits)

urethane hoses and clamps make your old kit look like new again. Available for most BBK cold air applications.



PERFORMANCE UNDERDRIVE PULLEY SYSTEMS

- + Bolt-On 10-15 Horsepower
- + Re-use Factory Serpentine Belts
- + Reduced Drag—Increased Mileage
- + Fully CNC Machined Construction
- + SFI Applications Available

BBK Performance underdrive pulley kits are available for many performance car and truck applications in powder coated steel or CNC machined finish billet aluminum. These popular direct replacement pulley kits are designed to replace the factory OE pulleys to slow down the front accessories and add more horsepower to rear wheels. Each BBK kit is vehicle specific and has been designed for use with the factory serpentine belt and to retain full cooling and charging characteristics. All kits are direct bolt-on with no modifications required



TOP SELLER

1979-1995 FORD MUSTANG & F-SERIES TRUCK SYSTEMS

Since 1988 the BBK team has been designing & building high quality performance underdrive pulley systems for the popular Ford 302/351 Mustang & F-Series truck applications. Designed to work with the stock serpentine belt, each kit features a brand new fully CNC machined lightweight aluminum crankshaft, water pump & alternator pulley and will free up an additional 8-15 HP without sacrificing normal charging & cooling.

- 1553—3 piece Kit – 79-95 Ford Mustang 5.0L / 86-96 Ford F-Series Truck 302/351 – CNC Billet Aluminum Machined Finish
- 1554—3 piece Kit – 94-95 Ford Mustang 5.0L – CNC Billet Aluminum Machined Finish



1996-2004 FORD MUSTANG SYSTEMS

Just like our other popular underdrive pulley systems, our 3 piece Mustang 4.6L GT & Cobra applications are available only in CNC machine finished billet aluminum. Each kit is specific to its application and includes a new crank, water pump and alternator pulley designed to work with the factory serpentine belt to ensure a simple installation. Please note the application for 2001 Mustang changes mid year—visit our website for more information.

- 1555—3 piece Kit – 1996-2001 1/2 Mustang 4.6L GT & Cobra – CNC Billet Aluminum—Machined finish
- 1559—3 piece Kit – CNC Billet Aluminum—2001 1/2 -2004 Mustang 4.6L GT (will not fit 03-04 Cobra)—Machined finish
- 1619—2 piece Kit – CNC Billet Aluminum—1996-1998 Mustang 3.8L V6 (requires new belt)—Machined finish

UNDERDRIVE
PULLEYS



1985-1995 GM AUTO & TRUCK SYSTEMS

Bolt-on 10-15 horsepower with these three piece aluminum underdrive pulley systems for your favorite GM auto and truck application CNC billet aluminum construction with machined finish.

- 1598—3 Piece Underdrive Pulley Kit – 1985-87 305/350 Camaro/Firebird, Monte Carlo & GM Truck
- 1620—3 Piece Underdrive Pulley Kit – 1988-92 305/350 Camaro/Firebird
- 1603—3 Piece Underdrive Pulley Kit – 1988-95 GM Truck—4.3L, 5.0L, 5.7L

All BBK Power Plus Series Underdrive Pulleys
Feature Full CNC Machined Aluminum Construction
For Maximum Performance & Quality



1993-1997 GM CAMARO / FIREBIRD / LT1 UNDERDRIVE PULLEY KIT

Owners of the popular LT1 equipped 93-97 Camaro/Firebird models can now free up an additional 10-15 horsepower in under an hour by installing one of our easy to Install Underdrive crank pulley kit. This performance pulley is CNC machined from billet aluminum and includes all the required new hardware for a simple installation.

1591—Performance Underdrive Crank Pulley Kit – 1993-97 GM LT1



1997-2003 FORD F-SERIES / EXPEDITION 4.6L/5.4L UNDERDRIVE PULLEY KIT

These three piece CNC billet aluminum underdrive pulley kits for owners of 97-03 Fords F-Series & Expeditions deliver 10-14 horsepower while improving towing performance. These 8 rib pulley kits include crank, water pump and alternator pulleys and re-use the factory OEM serpentine belt.

15550—3pc-8 Rib Performance Underdrive Pulley Kit – 1997-03 F-Series Truck 4.6L/5.4L & Expedition

FORD&GM SFI SYSTEMS

- + Bolt-On 9-12 Horsepower
- + SFI Certified Crank / Damper Pulley
- + Most Kits Use Stock Serpentine Belts

For those Mustang & GM LS-1 enthusiasts looking for the proven horsepower of under drive engine pulleys with an SFI approved crank/damper, these all new kits are just the ticket. Built from high quality CNC machined aluminum and steel, each kit is designed as a direct bolt-on in place of the stock kit and will work on basic street or more radical strip applications. Depending on the specific vehicle, these kits are available in a 2-piece or 3-piece versions. As with our traditional pulley systems, horsepower gains are approximately 9-12 rear wheel horsepower with the benefit of reduced drag which also helps with overall fuel economy.



- *1653—SFI Balancer Crank/Water Pump Kit (2005–2009 Mustang GT) 2-piece Kit
- *1564—SFI Balancer Crank/Water Pump/Alternator Kit (1996–01 Mustang GT) 3-piece Kit
- *1608—SFI Balancer Crank/Water Pump/Alternator Kit (2001–04 Mustang GT) 3-piece Kit
- *1592—SFI Balancer Crank/Alternator Kit (1998–02 LS-1 Camaro/Firebird) 2-piece Kit
- *1593—SFI Balancer Crank/Alternator Kit (1997–04 LS-1 Corvette) 1-piece Kit

*See water pump pulley guide at www.bbkperformance.com to verify fitment on 1996–2004 Mustangs



2007-2014 GT500 2.65" SUPERCHARGER PULLEY

Our fully CNC machined 2.65" supercharger pulley for 2007-2014 Mustang GT500 models will deliver about 3 PSI additional boost which translates to up to over 100 RWHP and 100 lb-ft of torque over stock. For maximum strength, this pulley is machined from high strength steel.

NEW 2000—Supercharger Pulley System (2007-2014 Mustang GT500)



1979-1995 MUSTANG 5.0L BILLET ALUMINUM SMOG PUMP ELIMINATOR KIT

Designed for the weekend or full time drag race application, this smog pump eliminator kit will free up horsepower for track use by eliminated drag losses. Built from fully CNC machined lightweight aluminum these kits are designed to look as good as they perform. Note: These kits are not legal for use on pollution controlled motor vehicles.

NEW 2001—Billet Aluminum Smog Eliminator Kit (1979-1995 Mustang 5.0L)

5.7L / 6.1L / 6.4L HEMI CHALLENGER, CHARGER & 300 HEADERS

Now available in chrome, silver ceramic or stainless steel finishes, these all new headers feature 3/8" laser cut flanges to prevent heat distortion and 1-3/4" heavy gauge CNC mandrel-bent tubing for improved horsepower and torque. The shorty tuned-lengths are a direct bolt-on and have shown an increase at the rear wheels of &21 horsepower and 16 lb-ft of torque over stock! The full-length headers have shown even bigger numbers and are available with catalytic or off-road mid-pipes.



- 4012—Shorty Tuned-Length 05-12 5.7L Hemi Headers – Chrome
- 40120—Shorty Tuned-Length 05-12 5.7L Hemi Headers – Polished Ceramic
- 1412—High Performance Header Gasket kit – 05-12 Hemi
- 4013—1-7/8" Shorty Tuned Length 05-14 6.1L-6.4L Hemi Headers – Polished Ceramic
- 40130—1-7/8" Shorty Tuned Length 05-14 6.1L-6.4L Hemi Headers – Chrome

50STATELEGAL

EO# PENDING

See Website For Update

5.7L HEMI RAM TRUCK PERFORMANCE HEADERS

50STATELEGAL

EO# PENDING

See Website For Update



With an increase of around 17 horsepower on an otherwise stock Ram, our tuned length performance headers for Hemi Ram owners are a great way to increase performance and towing capabilities. As with all BBK premium exhaust headers each system features computer mandrel bent tubing and a host of high quality American built components to ensure maximum quality and a perfect fit.

- 4009—Tuned Length Performance Headers (2004-08 Hemi Ram) – Chrome
- 40090—Tuned Length Performance Headers (2004-08 Hemi Ram) – Polished Ceramic
- 4014—Tuned Length Performance Headers (2009-12 Hemi Ram) – Chrome
- 40140—Tuned Length Performance Headers (2009-12 Hemi Ram) – Polished Ceramic
- 1412—2009-2012 Premium Header Gasket Kit

5.7L / 6.1L / 6.4L HEMI, CHALLENGER, CHARGER, MAGNUM & 300 PERFORMANCE FULL LENGTH HEADER SYSTEMS

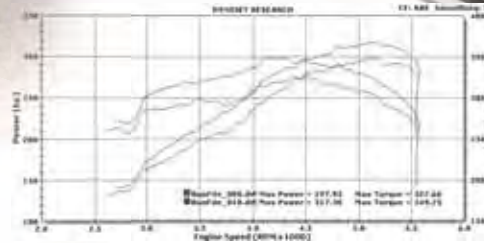

- + Bolt-On Over 30 Horsepower
- + 1- 3/4" & 1-7/8" Designs
- + Available In Chrome, Ceramic & 304 SS

With the high-powered Hemi motors now occupying the engine bays of the Chrysler 300, Magnum, Charger models and the recently introduced Challenger, the Mopar faithful have never had so many great performance platforms to modify. In addition to our Power-Plus® Series performance throttle bodies and cold-air systems which can be found within this catalog, our team has designed these high-flowing 304 Series® stainless steel performance Full-length header & X-pipe systems. With their awesome all stainless steel construction and 30–40 horsepower increase, no other bolt-on will deliver as much bang for the buck. All 304 Series® systems come complete with high quality graphite gaskets and stainless hardware for maximum satisfaction.

FULL-LENGTH HEADERS

- 1647—2005-12 5.7L Hemi 1-3/4" Headers – Chrome
- 16470—2005-12 5.7L Hemi 1-3/4" Headers – Polished Ceramic
- 1648—2005-14 6.1L / 6.4L Hemi 1-7/8" Headers – Chrome
- 16480—2005-14 6.1L / 6.4L Hemi 1-7/8" Headers – Polished Ceramic

MATCHING HIGH-FLOW DIRECT FIT X-PIPES

- 1796—2005-12 5.7L 2-3/4" X-Pipe w/Converters
- 1797—2005-12 5.7L 2-3/4" Off-Road X-Pipe
- 1798—2005-14 6.1L / 6.4L 3" X-Pipe w/Converters
- 1799—2005-14 6.1L / 6.4L 3" Off-Road X-Pipe
- 1405—5.7L / 6.1L Premium Header Gasket Kit

O² DIRECT PLUG-IN EXTENSION KIT-FORD/ GM/DODGE APPLICATION

Designed with OEM connectors to ensure trouble free operation and installation when installing full-length headers and high flow off-road race pipes.

- 1676—O² Sensor Wire Extension Kit – 1986-08 V-8 Mustang (Pair)
- 1110—O² Sensor Wire Extension Kit – 2011-14 Mustang GT/V6 (Pair)
- 1111—O² Sensor Wire Extension Kit – 2011-14 Mustang V6 (Front)
- 1112—O² Sensor Wire Extension Kit – 2011-14 Mustang GT (Front)
- 1115—O² Sensor Wire Extension Kit – GM
10-15 Camaro and C6 Corvette – 12"
- 1116—O² Sensor Wire Extension Kit – GM
10-15 Camaro and C6 Corvette – 36"
- 1118—O² Sensor Wire Extension Kit – Dodge – 12"



1986-95 MUSTANG 5.0L 1-5/8" TUNED LENGTH HEADERS

- + Computer Mandrel Bent Tubing
- + 1- 5/8" High-Flow Design
- + Bolt-On 10-15 Horsepower

When looking for quality, performance and value in a bolt-on 5.0 liter header kit — no other brand can compare to our list of shorty headers for 1986-95 5.0 liter Mustang applications. The available 1-5/8" tube diameter allows for a perfect match with all levels of performance. And the distinctive quality of our CNC Series® guarantees many years of enjoyable performance. All shorty headers are also available with our optional high-temp show quality polished ceramic coating.

- 1515—1-5/8" 1986-93 Shorty Headers – Chrome
- 15150—1-5/8" 1986-93 Shorty Headers – Polished Ceramic
- 1525—1-5/8" 1994-95 Shorty Headers – Chrome
- 15250—1-5/8" 1994-95 Shorty Headers – Polished Ceramic
- 1575—Hi-Performance Header Gasket Kit Small Block Ford



50STATELEGAL

EO# D-245-16

1986-95 MUSTANG 5.0L 1-5/8" EQUAL LENGTH HEADERS

- + Bolt-On 12-16 Horsepower
- + Unique Equal Length Design
- + Direct Bolt-On

SEE
ONLINE
VIDEO

50STATELEGAL

EO# D-245-16

The magazine header shoot-outs prove it, no one can match the performance gains of our 50-State-EPA-Legal equal-length shorty headers for owners of 1986-95 Mustang 5.0 liter models. Built with the same high quality features as all our CNC Series® Premium exhaust products — these headers are guaranteed to give the most "bang-for-the-buck."

- 1512—1986-93 Equal-Length – Chrome
- 15120—1986-93 Equal-Length – Polished Ceramic
- 1529—1994-95 Equal-Length – Chrome
- 15290—1994-95 Equal-Length – Polished Ceramic
- 1575—Hi-Performance Header Gasket Kit Small Block Ford

1996-04 MUSTANG 4.6L 1-5/8" TUNED LENGTH 2V PERFORMANCE HEADERS

- + Bolt-On 10-14 Horsepower
- + Direct Bolt-On Design

Dyno proven to deliver 10-14 horsepower on stock 1996-04 Mustang GT models with even more depending on other power adders, our tuned length performance headers offer unmatched performance and value. As with all BBK performance headers, standard features include heavy gauge computer mandrel bent tubing, 3/8" thick flanges and true American built craftsmanship. These headers include new gaskets and hardware for an easy installation and are available in chrome or polished ceramic finishes.

1615—Tuned Length Performance Headers (1996-04 Mustang 4.6L GT) – Chrome
16150—Tuned Length Performance Headers (1996-04 Mustang 4.6L GT) – Polished Ceramic
1401—1996-04 Premium Header Gasket Kit



50STATELEGAL

EO# D-245-16

2005-10 MUSTANG GT 1-5/8" TUNED LENGTH HEADERS

- + Bolt-On 12-16 Horsepower
- + Computer Mandrel Bent Tubing



1612—Tuned Length Performance Headers (2005-10 Mustang GT) – Chrome
16120—Tuned Length Performance Headers (2005-10 Mustang GT) – Polished Ceramic
16125—Tuned Length Performance Headers (2005-10 Mustang GT) – 304 Stainless Steel
1403—2005-10 Premium Header Gasket Kit

50STATELEGAL

EO# D-245-16

Designed for Ford's super popular 2005-10 Mustang GT, our tuned length performance headers quickly became a top power adder with Mustang enthusiasts demanding the most performance and the highest quality levels. Built here in the USA, our standard features such as heavy gauge computer mandrel bent tubing, 3/8" thick flanges and precision hand and robotic welds guarantee quality the China mimics can't touch. In addition to our normal chrome and polished ceramic finish options, these units are also available in full 304 series stainless steel.

2011-14 MUSTANG GT TUNED LENGTH 5.0L HEADERS

- + Bolt-On 12-16 Horsepower
- + Easy Bolt-On Installation
- + Available In Chrome, Polished Ceramic & 304 Stainless Steel



With the introduction of Ford's next generation 5.0L Mustang in 2011 our engineers were busier than ever developing an array of performance bolt-on for this newest Mustang. One the first and best performing of these power bolt-ons were these all new tuned length performance headers. Featuring high flowing computer mandrel bent 1-5/8" primary tubes these headers add 12-16 horsepower while retaining OEM quality and drivability. Supplied with new gaskets and premium hardware these headers are a simple bolt-on requiring no cutting or modifications. For even more power be sure to check out our new 5.0L air intakes and throttle bodies.

1632—Tuned Length Performance Headers (2011-14 Mustang 5.0L)—Chrome
 16320—Tuned Length Performance Headers (2011-14 Mustang 5.0L)—Polished Ceramic
 1410—High Performance Graphite Header Gasket Kit (2011-14 Mustang 5.0L)

50STATELEGAL

EO# D-245-16

2011-2016 MUSTANG 3.7L TUNED LENGTH HEADERS & HIGH-FLOW X-PIPES

- + Direct Bolt-On 2011-2016 Mustang V6 Models
- + Bolt-On 14-16 RWHP
- + CNC Mandrel Bent 1-5/8" Tubing
- + Available in both Chrome and Polished Ceramic finishes

These all new 2011-2016 Ford Mustang V6 1-5/8" shorty tuned length headers and X-pipes have already proved to be very popular with V6 owners and we have received great feedback from the Mustang forums about the great fit, quality and performance they are offering V6 enthusiasts right out of the box. The exhaust headers are available with our optional high-temp, show quality polished ceramic coating or chrome finish. Every header will fit all stock or aftermarket exhaust systems and give owners an additional 14-16 horsepower and 10-12 lb-ft of torque. Owners can add even more performance with one of our matching 2-1/2" CNC mandrel bent high flow X pipes available with high flow catalytic converters or off road versions.

*1442—1-5/8" Shorty Tuned Length Exhaust Headers
 2011-16 Mustang V6 3.7L—Chrome Finish
 *14420—1-5/8" Shorty Tuned Length Exhaust Headers
 2011-16 Mustang V6 3.7L—Polished Ceramic Finish
 1814—2.5" Full Length High Flow X Pipe with Catalytic Converters
 2011-2014 Mustang V6 3.7L
 18140—2.5" Full Length High Flow X Pipe Off Road Race Only
 2011-2014 Mustang V6 3.7L
 *1411—Premium Header Gasket Kit



50STATELEGAL

EO# D-245-16

1999-2010 MUSTANG V6 PERFORMANCE HEADER SYSTEMS

- + Available For 1999-04 And 2005-10
- + All Are Designed As Easy Bolt-On
- + Adds 8-14 Horsepower

With the rising fuel prices and continually better factory horsepower per liter numbers, the V6 versions of Ford's popular Mustang have really caught on with today's enthusiasts. One of the most popular upgrades along with air intakes and throttle bodies has been our tuned length performance header systems which are available for the 1999-2014 versions of this Pony car. Featuring heavy gauge computer mandrel bent 1-5/8" tubing and true American craftsmanship, each kit is designed as a simple bolt-on and includes new hardware and gaskets and does not require any cutting or welding.

- 4008—Tuned Length Performance Headers (1999-04 Mustang 3.8L / 3.9L V6) – Chrome
- 40080—Tuned Length Performance Headers (1999-04 Mustang 3.8L / 3.9L V6) – Polished Ceramic
- 4010—Tuned Length Performance Headers (2005-10 Mustang 4.0L V6) – Chrome
- 40100—Tuned Length Performance Headers (2005-10 Mustang 4.0L V6) – Polished Ceramic
- 1407—1999-04 Premium Header Gasket Kit
- 1408—2005-10 Premium Header Gasket Kit



2011-14 MUSTANG GT 2-3/4" HIGH-FLOW X-PIPES

- + Direct Bolt-On, No Cutting Or Welding
- + Add Up to 14 Horsepower
- + Available For Street & Race Only

Featuring 2-3/4" high flowing computer mandrel bent tubing and true American built quality, these new high flow X-Pipes for 2011-14 Mustang 5.0L models are a great power adder. Designed to fit with the factory or BBK aftermarket tuned length headers, these X-Pipes will deliver an additional 9-14 horsepower along with a more aggressive exhaust note.

- 1460—High Flow After Cat Legal X-Pipe (2011-14 Mustang 5.0L)
- *1674—Off Road Cat Pipes (Direct Replacement For System Converters)

*This Product is NOT EPA legal for street use and is intended for Off Road racing only. Will not fit 2011 models manufactured from March 2010 through August 2010

2005-09 MUSTANG V6 DUAL EXHAUST CONVERSION

- + Direct Bolt-On
- + Works With Stock Or BBK V6 Headers



Now owners of the very popular 2005-09 V6 Mustangs can easily bolt-on a true dual exhaust from the manifolds back! This kit includes a 2-1/2" mandrel-bent aluminized steel X-pipe and drivers side tailpipe to bolt up to the existing passenger side tailpipe (already 2-1/2" mandrel bent) allowing the use of any GT axle back muffler kit! The kit is complete with a template to trim the tailpipe opening on the driver side simply with a sharp razor knife. Give that V6 the looks and sound of the GT!

4011—Mustang V-6 Dual Exhaust Conversion Kit (2005-09)
Requires the installation of an aftermarket "axle-back" kit for a 2005-09 Mustang GT to complete

1973-93 MUSTANG 351 SWAP HEADERS



Mustang enthusiasts swapping one of Ford's popular 351W model engines into there Fox Body (1979-93 Mustang) have for years counted on the unmatched performance and quality of our 351 swap headers. Available in a tuned length version or a true long tube design , these header systems are designed as a true bolt-on and perfect for your Mustang street or strip project. As with all BBK headers each features computer mandrel bent heavy gauge tubing, 3/8" thick flanges, precision

welds and true American built quality units available in both chrome or polished ceramic finishes.

- *1511—Tuned Length 1-5/8" 351 Swap Headers (1979-93 Mustang) – Chrome
- *15110—Tuned Length 1-5/8" 351 Swap Headers (1979-93 Mustang) – Polished Ceramic
- 1569—Long Tube 1-3/4" 351 Swap Headers (1979-93 Mustang) – Chrome
- 15690—Long Tube 1-3/4" 351 Swap Headers (1979-93 Mustang) – Polished Ceramic
- 1575—1-5/8" High Performance Header Gasket Kit
- 1400—1-3/4" High Performance Header Gasket Kit

FORD PERFORMANCE EXHAUST

1-5/8" 1997-08 F-SERIES / EXPEDITION 4.6L / 5.4L HEADERS

- + Bolt-On 8-12 Horsepower
- + Includes New Gaskets & Hardware
- + Improves Towing Performance

Designed and built right here in the USA, our premium tuned length performance headers for Ford's popular 1997-08 F-Series/ Expedition models are built to stand up to the high demands of these models. Featuring heavy gauge 1-5/8" computer mandrel bent tubing, 3/8" thick flanges, beefy collectors and new gaskets and hardware for an easy installation - you are assured quality to match the performance. Choose from either our popular chrome or polished ceramic finishes.

- 3515—Tuned Length Performance Headers (1997-03 4.6L F150/Expedition) – Chrome
- 35150—Tuned Length Performance Headers (1997-03 4.6L F150/Expedition) – Polished Ceramic
- 3516—Tuned Length Performance Headers (1997-98 5.4L F150/Expedition) – Chrome
- 35160—Tuned Length Performance Headers (1997-98 5.4L F150/Expedition) – Polished Ceramic
- 3518—Tuned Length Performance Headers (1999-03 5.4L F150/1999-02 5.4L Expedition) – Chrome
- 35180—Tuned Length Performance Headers (1999-03 5.4L F150/1999-02 5.4L Expedition) – Polished Ceramic
- 1650—Tuned Length Performance Headers (2004-08 F150) – Chrome
- 16500—Tuned Length Performance Headers (2004-08 F150) – Polished Ceramic
- 1401— 4.6L Premium Header Gasket Kit
- 1402— 5.4L Premium Header Gasket Kit

EO# D-245-16

50STATELEGAL

1-5/8" 1987-95 302 / 351 F-150 HEADERS

- + Bolt-On 9-12 Horsepower
- + Direct Bolt-On Design
- + Available In Chrome Or Polished Ceramic

Since the late eighties owners of the popular 302/351 equipped 1987-95 Ford F150 have enjoyed the performance and quality benefits of our tuned length performance headers for these models. Featuring heavy gauge computer mandrel bent tubing, beefy 3/8" thick flanges and precision welds - these performance headers will last as well as they perform. These units are available in either our chrome or polished ceramic finishes and come complete with new gaskets and hardware for an easy installation and require no cutting or welding.

- 3510 —Tuned Length Performance Headers (1987-95 302 F150) – Chrome
- 35100—Tuned Length Performance Headers (1987-95 302 F150) – Polished Ceramic
- 3511—Tuned Length Performance Headers (1987-95 351 F150) – Chrome
- 35110—Tuned Length Performance Headers (1987-95 351 F150) – Polished Ceramic
- 1575—Premium Header Gasket Kit

50STATELEGAL

EO# D-245-16

1979-95 LONG TUBE HEADERS

- + Direct Bolt-On, Matching Mid-Pipes Below
- + Bolt-On 20-30 Horsepower
- + Available In Chrome Or Polished Ceramic
- + Now Available For Automatics and Coyote 5.0 Engine Swaps

Available in both 1-5/8" and 1-3/4" versions for all performance levels, our 1979-95 Mustang long tube performance headers have been a must with serious Mustang enthusiasts who demand top American built quality and the best performance available. To ensure a simple installation we also offer matching mid pipes that allow a direct bolt in with our OEM style gasket less large 2.5" outlet dome style collectors. We have also introduced 2 new applications to our Mustang long tube header application list - firstly we now offer long tubes specifically for the automatic 79-93 Fox body with matching short mid x pipes and for owners short mid x pipes and for owners wanting to add a modern 5.0 Ford Coyote engine as a swap we offer our 1-3/4" Coyote swap headers and matching short mid x-pipes to maximize horsepower and torque.



- 1516—1-5/8" Long Tube Headers (1979-93 Mustang 5.0L) – Chrome
- 15160—1-5/8" Long Tube Headers (1979-93 Mustang 5.0L) – Polished Ceramic
- 1519—1-5/8" Long Tube Headers (1994-95 Mustang 5.0L) – Chrome
- 15190—1-5/8" Long Tube Headers (1994-95 Mustang 5.0L) – Polished Ceramic
- 1594—1-3/4" Long Tube Headers (1979-93 Mustang 5.0L) – Chrome
- 15940—1-3/4" Long Tube Headers (1979-93 Mustang 5.0L) – Polished Ceramic
- 1531—1-5/8" Automatic Long Tube Exhaust Headers (1979-93 Mustang 5.0) – Chrome
- 15310—1-5/8" Automatic Long Tube Exhaust Headers (1979-93 Mustang 5.0) – Polished Ceramic
- 1634—1-3/4" 5.0 Coyote Swap Long Tube Exhaust Headers (1979-95 Mustang 5.0) – Polished Ceramic
- 16340—1-3/4" 5.0 Coyote Swap Long Tube Exhaust Headers (1979-95 Mustang 5.0) – Chrome
- 1575—1-5/8" Hi Performance Header Gasket Kit – SB Ford
- 1400—1-3/4" Hi Performance Header Gasket Kit – SB Ford
- 1410—1-3/4" Hi Performance Header Gasket Kit – 11-14 5.0 Coyote

Use with matching mid-pipes listed below for direct bolt-on

1979-95 MATCHING HIGH-FLOW MID-PIPES

- + Direct Bolt-On With Above Headers
- + Available For Street Or Race
- + High-Flow 2.5" Computer Mandrel Bent Tubing

To ensure a simple installation with the above long tube header systems, we offer these matching high flow performance mid pipes. Available in H- & X-pipe versions with high flow converters or in off road only race versions, these mid pipes are a direct bolt-on requiring no cutting or welding when used with the matching BBK long tube headers.

- *1509—2.5" H-Pipe with Converters (fits 1516, 15160, 1569, 15690 long tube headers)
- **1510—2.5" Off-Road H-Pipe (fits 1516, 15160, 1569, 15690 long tube headers)
- *1659—2.5" X-Pipe with Converters (fits 1516, 15160, 1569, 15690 long tube headers)
- **1660—2.5" Off-Road X-Pipe (fits 1516, 15160, 1569, 15690 long tube headers)
- **1671—2.5" Off-Road X-Pipe (fits 1519, 15190 long tube headers)
- *1672—2.5" X-Pipe with Converters (fits 1519, 15190 long tube headers)
- *1810—2.5" Short Mid X Pipe With Converters For 1531/15310 Exhaust Headers (1979-93 Mustang 5.0)
- *1811—2.5" Short Mid X Pipe Off Road Use Only For 1531/15310 Exhaust Headers (1979-93 Mustang 5.0)
- *1786—2.5" Short Mid X Pipe Off Road Use Only For 1634/16340 Exhaust Headers (1979-95 Swap Mustang 5.0)
- *1787—2.5" Short Mid X Pipe With Converters For 1634/16340 Exhaust Headers (1979-95 Swap Mustang 5.0)

*Converters are 49 state legal - cannot be used or sold in the state of California

**Off Road Use pipes are NOT EPA street legal in any state and are intended for race use only



1996-04 MUSTANG GT / COBRA LONG TUBE HEADERS

- + Direct Bolt-On, Matching Mid-Pipes Page 48
- + Bolt-On 18-24 Horsepower
- + Available In Chrome Or Polished Ceramic
- + New Coyote 5.0 Swap Headers Now Available



Owners of the 1996-04 4.6L equipped Mustang GT and Cobra models have long enjoyed the proven performance

and unmatched American built quality of these performance long tube header systems. Designed to perfectly fit the chassis of these 4.6L overhead cam motors, each system tucks up cleanly like the factory exhaust yet delivers a whopping 18-24 rear wheel horsepower on an otherwise stock Mustang. Computer mandrel bent tubing, beefy 3/8" thick flanges and precise welds ensure a perfect fit and unmatched longevity. These header systems include new gaskets and hardware and are available in chrome or polished ceramic finishes. Matching mid

pipes are available on the next page which allow a true bolt-on installation. We have also introduced our new 1-3/4" 5.0 Ford Coyote engine swap headers for owners looking up grade the tired 4.6 2V or 4V motors to maximize horsepower and torque - require matching short mid x pipes.

- 1532—1-5/8" Performance Long Tube Headers (1996-98 Mustang Cobra) – Chrome
- 15320—1-5/8" Performance Long Tube Headers (1996-98 Mustang Cobra) – Polished Ceramic
- 1533—1-5/8" Performance Long Tube Headers (1999-04 Mustang Cobra/Mach 1) – Chrome
- 15330—1-5/8" Performance Long Tube Headers (1999-04 Mustang Cobra/Mach1) – Polished Ceramic
- 1541—1-5/8" Performance Long Tube Headers (1996-04 Mustang GT/Bullitt) – Chrome
- 15410—1-5/8" Performance Long Tube Headers (1996-04 Mustang GT/Bullitt) – Polished Ceramic
- 1634—1-3/4" 5.0 Coyote Swap Long Tube Exhaust Headers (1996-04 Mustang) – Polished Ceramic
- 16340—1-3/4" 5.0 Coyote Swap Long Tube Exhaust Headers (1996-04 Mustang) – Chrome
- 1410—1-3/4" Hi Performance Header Gasket Kit – 11-14 5.0 Coyote

Use with matching mid-pipes listed below for direct bolt-on page 50

2005-10 MUSTANG GT LONG TUBE HEADERS

- + Bolt-On Over 30 Horsepower
- + Matching X-Pipes On Next Page



With Up to 30 rear wheel horsepower and nearly 30 lb-ft of torque, very few performance bolt-ons deliver the performance gains of these performance long tube header systems on 2005-10 Mustang GT models. Built from the highest quality materials and computer machined components each of these headers is a great example of true American craftsmanship. Choose from our chrome or polished ceramic finishes and remember that all hardware and gaskets are included for a simple bolt-on when used with one of our matching high flow mid pipes listed on the following page 52.

- 1641—1-5/8" Performance Long Tube Headers (2005-10 Mustang GT) – Chrome
- 16410—1-5/8" Performance Long Tube Headers (2005-10 Mustang GT) – Polished Ceramic
- 16415—1-5/8" Performance Long Tube Headers (2005-10 Mustang GT) – 304 Stainless Steel
- 1403—1-5/8" High Performance Header Gasket Kit (2005-10 Mustang GT)

Use with matching mid-pipes listed below for direct bolt-on page 50

1996-04 MUSTANG GT/COBRA HIGH-FLOW MID-PIPES

These matching high flow mid pipes are available in both H & X style configurations in either a converter street version or a race only off road design for all performance levels. Designed to be a direct bolt-on with our 1996-04 Mustang 4.6L Long tube headers, all can be installed without any cutting or welding. Fits headers on page 49.

- **1535—2.5" Off Road H-Pipe (fits 1532,15320,1533,15330,1541,15410 long tube headers)
- *1538—2.5" H-Pipe with Converters (fits 1532,15320,1533,15330,1541,15410 long tube headers)
- **1635—2.5" Off-Road X-Pipe (fits 1532,15320,1533,15330,1541,15410 long tube headers)
- *1638—2.5" X-Pipe with Converters (fits 1532,15320,1533,15330,1541,15410 long tube headers)
- *1786—2.5" Short Mid X Pipe Off Road Use Only For 1634/16340 Exhaust Headers (1979-95 Swap Mustang 5.0)
- *1787—2.5" Short Mid X Pipe With Converters For 1634/16340 Exhaust Headers (1979-95 Swap Mustang 5.0)

*Converters are 49 state legal - cannot be used or sold in the state of California

**Off Road Use pipes are NOT EPA street legal in any state and are intended for race use only



2005-10 MUSTANG GT HIGH-FLOW MID-PIPES

- + Direct Bolt-On For 1641/16410 Headers on Page 49
- + Available For Street Or Race Only Use

These high flow X-Pipes are designed to make our 2005-10 Mustang long tube headers a direct bolt-on while adding another 10-12 horsepower along with a more aggressive sound.

- **1636—2-3/4" Off-Road X-Pipe (fits 1641,16410 long tube headers)
- *1637—2-3/4" X-Pipe with Converters (fits 1641,16410 long tube headers)

*Converters are 49 state legal - cannot be used or sold in the state of California

**Off Road Use pipes are NOT EPA street legal in any state and are intended for race use only



2011-14 MUSTANG V6 LONG TUBE HEADER SYSTEMS & MATCHING X-PIPES

- + Bolt-On Up to 28 Horsepower
- + No Cutting Or Welding Required



By increasing the 2011-2014 Mustang V6 already impressive over 300 horsepower output by almost thirty more horsepower (10%) these new long tube headers are one way to get the new V6 performing like a V8 yet with 30MPG on the highway. Featuring computer mandrel bent tubing, 3/8" thick flanges, precision welds and a choice of chrome, polished ceramic or 304 stainless steel nothing comes close to there performance or quality.

- 1642—1-5/8" Performance Long Tube Headers—Chrome (2011-14 Mustang 3.7L V6)
- 16420—1-5/8" Performance Long Tube Headers—Polished Ceramic (2011-14 Mustang 3.7L V6)
- *1461—2.5" X-Pipe with Converters—Fits 1642 Series Headers
- **1462—2.5" X-Pipe—Off Road Pipe—Fits 1642 Series Headers

*Converters are 49 state legal - Cannot be used or sold in the state of California

**This Product is NOT EPA legal for street use and is intended for Off Road racing only

FORD PERFORMANCE EXHAUST

2007-12 MUSTANG GT500 LONG TUBE HEADER SYSTEMS

- + Bolt-On Over 30 Horsepower
- + Direct Bolt-On Design



FULL-LENGTH HEADERS AND MATCHING MID-PIPES

16490—2007-12 GT500 1-3/4" Ceramic Coated Headers

****16515**—2007-12 GT500 Short 2-3/4" Off-Road X-Pipe

***1851**—2007-12 GT500 Short Off-Road with Catalytic Converters

**Converters are 49 state legal – Cannot be used or sold in the state of California*

***This Product is NOT EPA legal for street use and is intended for Off Road racing only*

Bolt-on 30-40 horsepower to your 2007-12 Mustang GT500 with this beautiful 304-Series® performance Full-Length Header & X-Pipe system. Featuring the same high-quality 304-Series stainless steel computer mandrel-bent tubing, 3/8" thick laser / die-stamped flanges and precision welds – this system meets and exceeds the high demands of such vehicles as the GT500. To ensure maximum performance our engineers utilize European style steel core converters which will out-flow and out-last all other styles. Each header kit comes complete with high-quality graphite gaskets and all necessary hardware for a simple bolt-on installation.

2011-14 MUSTANG GT LONG TUBE HEADER SYSTEMS

- + Bolt-On 30 Plus Horsepower
- + Computer Mandrel Bent Tubing
- + 1-5/8" and 1-7/8" Available

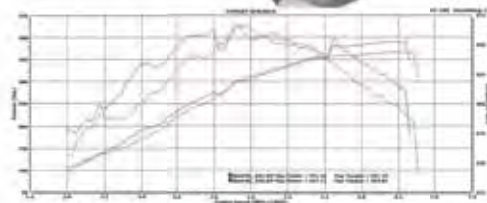

With approximately 30 additional horsepower and 30 lb-ft of torque, these all new long tube header systems really wake up Ford's already potent 412HP 2011-14 Mustang 5.0L giving them the power matching GM's larger 6.2L Camaro. Matched with our new air intake and performance throttle body and your talking maximum performance with normal drivability and mileage numbers. Unlike old school headers, these systems are designed to cleanly fit the factory parameters and are built here in the USA with the finest computer controlled components and precision welds you don't normally expect with an aftermarket header. Gaskets and hardware are included as is our chrome, polished ceramic or 304 stainless steel options.

SEE
ONLINE
VIDEO



1633—1-5/8" Performance Long Tube Headers—Chrome
(2011-14 Mustang 5.0L GT)

16330—1-5/8" Performance Long Tube Headers—Polished Ceramic
(2011-14 Mustang 5.0L GT)

16335—1-5/8" Performance Long Tube Headers—304 Stainless Steel
(2011-14 Mustang 5.0L GT)

1856—1-7/8" Performance Long Tube Headers—Chrome

18560—1-7/8" Performance Long Tube Headers—Polished Ceramic

HIGH FLOW X-PIPES

1655—3" Off Road X-Pipe (2011-14 Mustang 5.0L GT)

1658—3" X-Pipe with Converters (2011-14 Mustang 5.0L GT)



1986-98 2.5" MUSTANG HIGH-FLOW H-PIPES

- + Direct Fit With Stock Or BBK Headers
- + Bolt-On With 12-20 Horsepower
- + Available For Street Or Race Only

- **1507—High Flow 2.5" Off Road H-Pipe (1986-93 5.0L Mustang)
- **1562—High Flow 2.5" Off Road H-Pipe (1994-95 5.0L Mustang)
- **1565—High Flow 2.5" Off Road H-Pipe (1996-98 4.6L Mustang GT)
- **1566—High Flow 2.5" Off Road H-Pipe (1996-98 4.6L Mustang Cobra)
- **1507—High Flow 2.5" Off Road H-Pipe (1999-04 4.6L Mustang)
- *1521—High Flow 2.5" H-Pipe with Converters (1986-93 5.0L Mustang)
- *1563—High Flow 2.5" H-Pipe with Converters (1994-95 Mustang GT)

*Converters are 49 state legal – Cannot be used or sold in the state of California

**This Product is NOT EPA legal for street use and is intended for Off Road racing only

Designed with high flowing computer mandrel bent 2.5" aluminized tubing, OEM style die stamped flanges and factory style gasket less dome connections these performance H-Pipes deliver quality to match there great bolt-on performance. Engineered to fit either your Mustangs factory headers or our popular BBK Performance headers, these high flow mid pipes are available in a street version with performance converters or an race only off road version. Depending on the specific Mustang model and other upgrades, dyno testing has revealed consistent gains of 14-20 horsepower over stock along with a more aggressive sound.



1986-2010 2.5" MUSTANG HIGH-FLOW X-PIPES

- + Direct Fit With Stock Or BBK Headers
- + Bolt-On With 14-20 Horsepower
- + Available For Street Or Race Use

From our original 1986-93 high-performance X-pipes which Mustang enthusiasts have enjoyed for years, to our new applications for all 1994-2010 Mustang GT and Cobra models. Mustang owners can get the most performance for their money with BBK CNC-Series® off-road and high flow Cat X-pipes. All X-pipes are computer mandrel-bent from fully aluminized 2.5" diameter tubing to ensure maximum flow as well as longevity. OEM-style die-stamped flanges ensure a perfect fit and dyno testing has shown solid gains of 12-25 horsepower depending on the model and other modifications.

- **1616—2.5" Performance Off-Road X-Pipe (1996-98 4.6 Cobra)
- *1618—2.5" Performance X-Pipe with Converters (1996-98 4.6 Cobra)
- **1661—2.5" Performance Off-Road X-Pipe (1986-93 5.0 Mustang)
- *1662—2.5" Performance X-Pipe with Converters (1986-93 5.0 Mustang)
- *1663—2.5" Performance X-Pipe with Converters (1994-95 Mustang GT)
- **1664—2.5" Performance Off-Road X-Pipe (1994-95 Mustang GT)
- **1665—2.5" Performance Off-Road X-Pipe (1996-98 4.6 GT)
- *1666—2.5" Performance X-Pipe with Converters (1996-98 4.6 GT)
- **1669—2.5" Performance Off-Road X-Pipe (1999-2004 4.6 All)
- *1670—2.5" Performance X-Pipe with Converters (1999-2004 4.6 All)
- **1769—2-3/4" Performance High-Flow Off-Road X-Pipe (2005-10 Mustang GT)
- *1770—2-3/4" Performance X-Pipe w/Converters (2005-10 Mustang GT)
- *1698—2-3/4" Performance X Pipe With High Flow Converters (07-10 Mustang GT500)

*Converters are 49 state legal – Cannot be used or sold in the state of California

**This Product is NOT EPA legal for street use and is intended for Off Road racing only

1996-04 GM TRUCK HEADERS

Our performance tuned length headers for 1996-04 GM full size truck models are a great way to bolt-on 10-15 horsepower along with improved towing performance while retaining your factory drivability and mileage. Designed and built with the best possible materials and craftsmanship right here in the USA you can be assured that these performance headers will deliver the quality you demand in a design that is designed to bolt-on with no cutting or modifications. Gaskets and hardware are included and these headers are available in either our chrome or polished ceramic finishes.

- 4005—1-3/4" Performance Tuned Length Headers (1999-04 4.8L/5.3L GM truck)—Chrome
- 40050—1-3/4" Performance Tuned Length Headers (1999-04 4.8L/5.3L GM truck)—Polished Ceramic
- 4006—1-3/4" Performance Tuned Length Headers (1999-09 6.0L GM truck)—Chrome
- 40060—1-3/4" Performance Tuned Length Headers (1999-09 6.0L GM truck)—Polished Ceramic
- 4007—1-5/8" Tuned Length Performance Headers (1996-98 5.0L/5.7L GM truck)—Chrome
- 40070—1-5/8" Tuned Length Performance Headers (1996-98 5.0L/5.7L GM truck)—Polished Ceramic



50STATELEGAL

EO# D-245-18

1993-97 LT-1 / CAMARO / FIREBIRD / IMPALA SS

Enthusiasts with GM's 5.7L LT1 equipped 1993-97 Camaro/Firebird or 1993-96 Impala SS have enjoyed the awesome bolt-on performance of our performance tuned length header systems for years. Featuring all American built premium construction and a design that delivers 14-20 Horsepower over the factory exhaust manifolds, these headers deliver the most bang for the buck of any LT1 performance bolt-on. Includes custom high flow 2.5" Y-Pipe if required.

- 1595—1-5/8" Performance Tuned Length Headers (1993-96 Impala SS)—Chrome
- 15950—1-5/8" Performance Tuned Length Headers (1993-96 Impala SS)—Polished Ceramic
- 1567—1-5/8" Performance Tuned Length Headers/Y-Pipe (1994-95 Camaro/Firebird with factory single converter)—Chrome
- 15670—1-5/8" Performance Tuned Length Headers/Y-Pipe (1994-95 Camaro/Firebird with factory single converter)—Polished Ceramic
- 1568—1-5/8" Performance Tuned Length Headers (1995-97 Camaro/Firebird with factory dual converters)—Chrome
- 15680—1-5/8" Performance Tuned Length Headers (1995-97 Camaro/Firebird with factory dual converters)—Polished Ceramic
- 1596—1-5/8" Performance Tuned Length Headers/Y-Pipe (1993 Camaro/Firebird)—Chrome
- 15960—1-5/8" Performance Tuned Length Headers/Y-Pipe (1993 Camaro/Firebird)—Polished Ceramic



50STATELEGAL

EO# D-245-18

1997-04 C5 CORVETTE

Our 1-3/4" performance tuned length headers for 1997-04 C5 Corvette models offer unmatched quality and performance gains with a dyno proven 12-16 horsepower over stock. Designed and built here in the USA, each system features computer mandrel bent tubing, beefy 3/8" thick flanges, precision welds and standard polished ceramic finish. Designed as a true bolt-on with no cutting or welding required these are a great Saturday project for the Corvette enthusiast.

- 40000—1-3/4" Tuned Length Performance Headers (1997-99 Corvette)—Polished Ceramic
- 40040—1-3/4" Tuned Length Performance Headers (2001-04 Corvette)—Polished Ceramic



50STATELEGAL

EO# D-245-18

GM PERFORMANCE EXHAUST

GENERAL MOTORS

FORD

DODGE

1998–2002 1-3/4" LS-1 CAMARO / FIREBIRD

These 1-3/4" performance tuned length headers for 1998-2002 LS1 powered Camaro/Firebird models are a simple way to bolt-on 12-18 horsepower to your otherwise stock motor with even more performance when combined with other popular power adders. Featuring computer mandrel bent tubing, 3/8" thick flanges and either our chrome or polished ceramic finishes, no other aftermarket header delivers the performance value of these units.



4002—1-3/4" Tuned Length Performance Headers (1998-99 LS1 Camaro/Firebird) – Chrome
 4003—1-3/4" Tuned Length Performance Headers (2001-02 LS1 Camaro/Firebird) – Chrome
 40030—1-3/4" Tuned Length Performance Headers (2001-02 LS1 Camaro/ Firebird) – Polished Ceramic

50STATELEGAL

EO#D-245-18

1998–2002 1-3/4" LS-1 / CAMARO / FIREBIRD LONG TUBE HEADERS

These 1-3/4" long tube performance headers are a sure bet way to increase your LS1 equipped Camaro/Firebird output by almost 30 horsepower and 30 lb-ft of torque while retaining factory drivability and mileage. Designed with a new hi flow Y-Pipe assembly that is included in the kit, these headers are a direct bolt-on and even include new gaskets and hardware for the perfect weekend project.



1694—1-3/4" Long Tube Performance Headers/Y-Pipe Assembly (1998-02 LS1 Camaro/Firebird) – Chrome
 16940—1-3/4" Long Tube Performance Headers/Y-Pipe Assembly (1998-02 LS1 Camaro/Firebird) – Polished Ceramic

C5 / C6 / Z06 CORVETTE LONG TUBE SYSTEMS

Owners of the popular C5 & C6 Corvette models now have a reasonably priced high quality performance header upgrade with these new performance full length header systems with matching high flow mid pipes. With American designed & built quality and such standard features as computer mandrel bent 1-3/4" tubing, 3/8" thick laser cut flanges and standard polished ceramic finish, these headers will deliver up to 30 RWHP & 25 lb-ft right out of the box. No cutting or welding is required making installation very straightforward for the do it yourself enthusiast.



FULL-LENGTH HEADERS

NEW 16430—1997-2004 C5 Corvette 1-3/4" Full Length Headers (polished ceramic)
NEW 16450—2005-2008 C6 Corvette 1-3/4" Full Length Headers (polished ceramic)
NEW 40270—2009-2013 C6 Corvette 1-3/4" Full Length Headers (polished ceramic)

MATCHING HIGH-FLOW X-PIPES

NEW 1691—1997-2004 C5 Corvette 2-3/4" High Flow X-Pipe w/Converters
NEW 1693—2005-2008 C6 Corvette 3.0" High Flow X-Pipe w/Converters
NEW 1849—2009-2013 C6 Corvette 3.0" High Flow X-Pipe w/Converters



2010-2015 CAMARO 2010 G8 TUNED LENGTH HEADERS

- + Bolt-On 12-18 Horsepower
- + Available In Chrome, Polished Ceramic And 304 Stainless Steel

Our engineers did it again with these popular direct fit tuned length performance headers for the hot 2010-15 Camaro SS models/2010 G8 models. Featuring high flowing computer mandrel bent 1-3/4" primary tubes, 3/8" thick flanges, precision welds and chrome, polished ceramic or 304 series stainless steel, these headers look as good as they perform with a dyno proven 12-18 Horsepower increase over stock with the factory tune.

4020—1-3/4" Tuned Length Performance Headers (2010-15 Camaro SS/Pontiac G8) – Chrome
40200—1-3/4" Tuned Length Performance Headers (2010-15 Camaro SS / Pontiac G8) – Polished Ceramic
40205—1-3/4" Tuned Length Performance Headers (2010-15 Camaro SS/Pontiac G8) – 304-Stainless

50STATE LEGAL

EO# D-245-18

2010-2015 CAMARO RS / SS

- + Bolt-On Over 30 Horsepower And 30 lb-ft of torque
- + Available For RS And SS Models

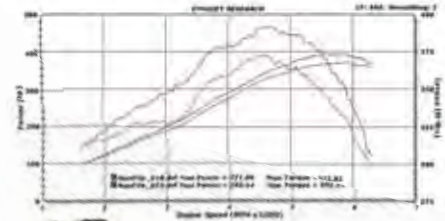

While our engineers anticipated an increase of about 30 horsepower for our long tube headers on the LS3/L99 Camaro based on what they had seen during development on LS3/L99 Corvette models, they weren't planning on similar power increases from the V6 RS models but that's exactly what they got. That's right almost 30 horsepower and 30 lb-ft of torque from your otherwise stock 2010-15 Camaro SS / 2010-11 Camaro RS with the factory tune and even more with additional power adders.

SEE
ONLINE
VIDEO

- *4021—1-3/4" Performance Long Tube Headers with converters (2010-15 Camaro SS) – Chrome
- *40210—1-3/4" Performance Long Tube Headers with converters (2010-15 Camaro SS) – Polished Ceramic
- *40215—1-3/4" Performance Long Tube Headers with converter (2010-15 Camaro SS) – 304-Stainless
- **4031—1-3/4" Performance Long Tube Headers with Off-Road Pipe (2010-15 Camaro SS) – Chrome
- **40310—1-3/4" Performance Long Tube Headers with Off-Road Pipe (2010-15 Camaro SS) – Polished Ceramic
- *4053—1-7/8" Performance Long Tube Headers with Off-Road Pipe (2010-15 Camaro SS) – Polished
- *40530—1-7/8" Performance Long Tube Headers with Converters (2010-15 Camaro SS) – Polished Ceramic
- *4041—1-5/8" Performance Long Tube Headers with Converters (2010-11 Camaro RS V6) – Chrome
- *40410—1-5/8" Performance Long Tube Headers with Converters (2010-11 Camaro RS V6) – Polished Ceramic
- *40415—1-5/8" Performance Long Tube Headers with Converters (2010-11 Camaro RS V6) – 304-Stainless

HIGH FLOW 2-3/4" X-PIPES

- 4023—2-3/4" High Flow X-Pipe (2010-15 Camaro SS) – Aluminized
- 4024—2-3/4" High Flow X-Pipe (2010-11 Camaro RS V6) – Aluminized

*Converters are 49 state legal – Cannot be used or sold in the state of California

**This Product is NOT EPA legal for street use and is intended for Off Road racing only

FULL LENGTH HEADERS GM / FORD / DODGE TRUCK

- + Bolt-On Up To 30 HP & 30 lb-ft
- + Improved Tuning And Off Road Capabilities
- + CNC Mandrel Bent Heavy Gauge Construction

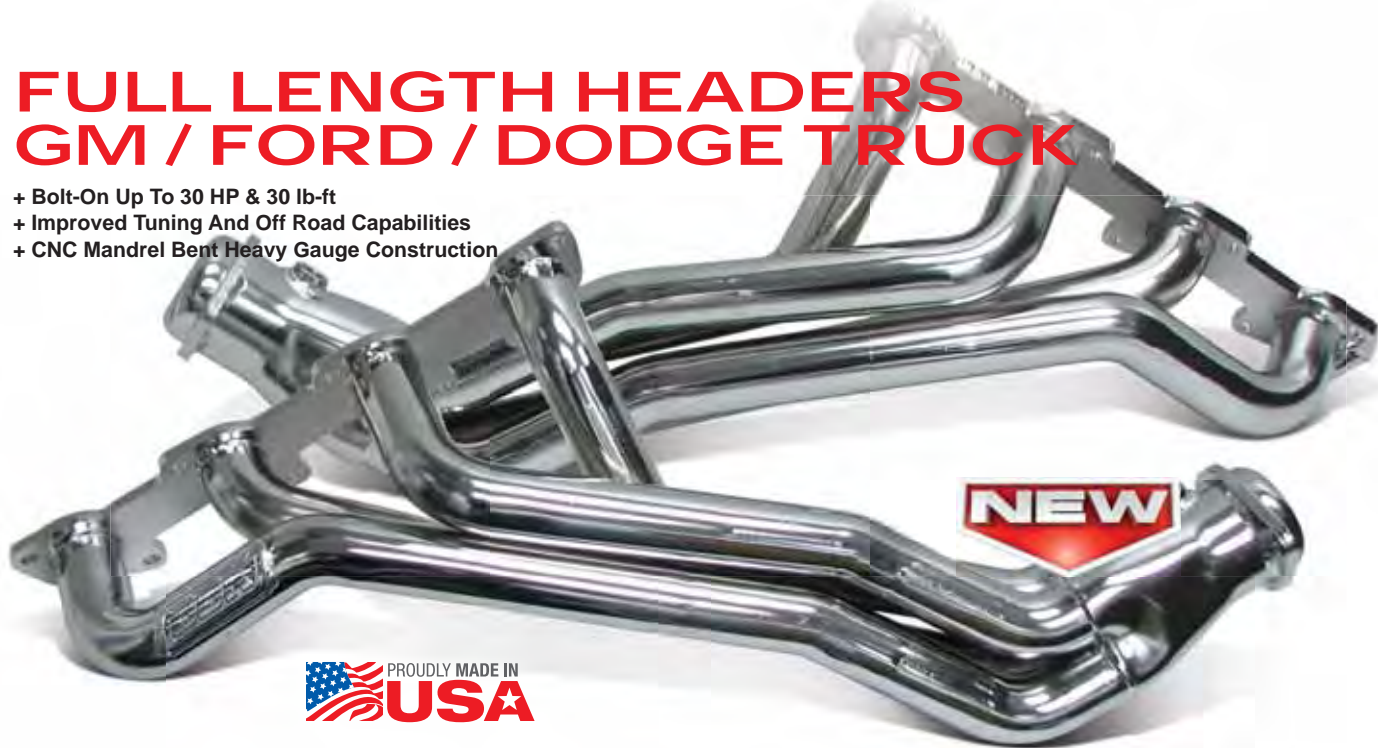

- NEW 3532**—2003-2011 Dodge Ram 5.7L Hemi 1-3/4" Full Lengths(chrome)
- NEW 35320**—2003-2011 Dodge Ram 5.7L Hemi 1-3/4" Full Lengths (polished ceramic)
- NEW 3530**—1997-2003 Ford F-Series 4.6L/5.4L 1-5/8" Full Lengths (chrome)
- NEW 35300**—1997-2003 Ford F-Series 4.6L/5.4L 1-5/8" Full Lengths (polished ceramic)
- NEW 1614**—1999-2002 GM 1-3/4" Full Lengths (chrome)
- NEW 16140**—1999-2002 GM 1-3/4" Full Lengths (polished ceramic)

Owners of America's top full size trucks can now buy an ultra high quality performance full length header system that designed & built right here in the USA with unmatched performance or quality. Designed to be a clean and heavy duty design, standard features include heavy gauge computer mandrel bent tubing, 3/8" thick laser cut flanges and chrome or polished ceramic finishes.

JEEP WRANGLER & JK PERFORMANCE HEADERS

- + Design And Built In The USA
- + Heavy Gauge CNC Mandrel Bent Tubing



Engineered & built to last right here in the USA using the highest quality materials and craftsmanship, our latest performance header system offerings for owners of Wrangler & JK model Jeep are second to none. Designed to give maximum performance while delivering a perfect fit, the 3.8L versions come as a complete system which includes a high flow mid pipe with steel core converters for maximum performance & longevity. Both the Wrangler & JK versions are available in a chrome or polished ceramic finish and come complete with new gaskets & hardware.

- 4050**—2007-2011 Jeep Wrangler 3.8L V6 1-5/8" Longtube Headers (chrome) & High Flow Mid Pipe w/converters
- 40500**—2007-2011 Jeep Wrangler 3.8L V6 1-5/8" Longtube Headers (polished ceramic) & High Flow Mid Pipe w/converters
- 4052**—1987-2007 Jeep Wrangler 4.0L 1-1/2" Tuned Length Headers (chrome)
- 40520**—1987-2007 Jeep Wrangler 4.0L 1-1/2" Tuned Length Headers (polished ceramic)

SEE
ONLINE
VIDEO

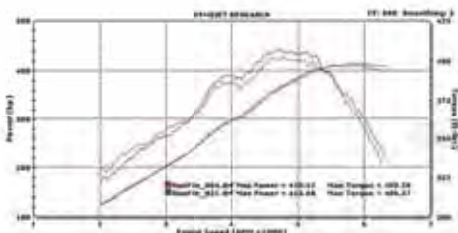
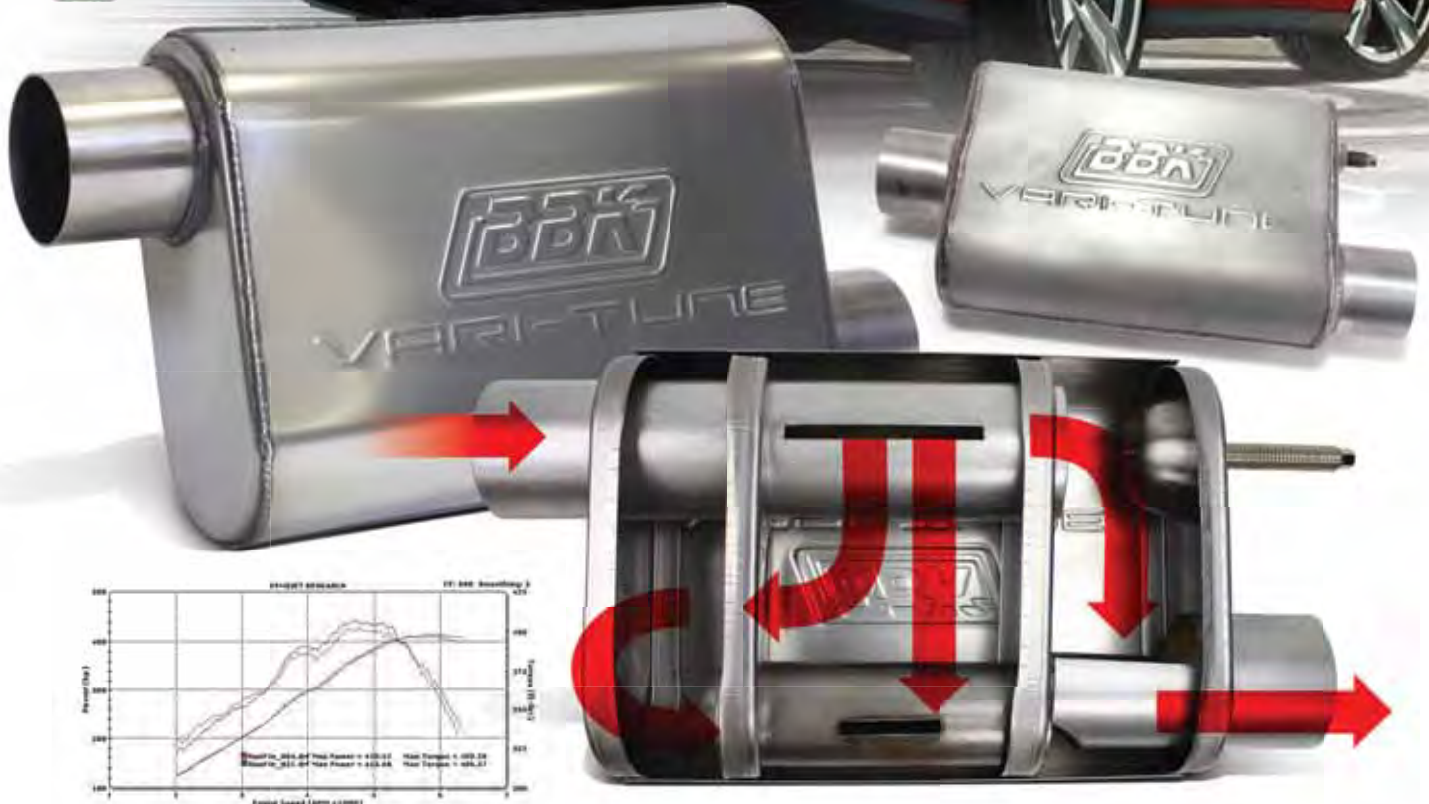

VARI-TUNE™

ADJUSTABLE PERFORMANCE MUFFLERS

- + Fully Adjustable Sound And Flow
- + Adjust In Minutes On The Car
- + Available In 2.5", 2.75" And 3.0"

PATENT # 8851231

A few years back when our R&D team set out to develop a new performance muffler for our then new axle back systems they new it had to be better than the competition and be built here in the USA with the best quality materials & craftsmanship. What they didn't know is that they would be designing a revolutionary design that would incorporate our now patented "Internal Power Valve" allowing for tenability and increased performance over other brands.

Our Varitune mufflers literally let enthusiasts simply set there sound & performance levels at the turn of a wrench which varies this muffler from a mellow multi chamber design to a free flowing and attention getting single chamber style muffler. In addition to this great design each Varitune muffler is custom built and robotically welded using the highest quality materials. Extensive dyno testing has shown typical gains of 8-15 RWHP over stock and even more when used as part of our Varitune axle back & cat back exhaust systems seen on the following pages of this catalog. Varitune mufflers are available in a variety of sizes & offsets to accommodate hundreds of vehicle applications and are available in aluminized or stainless steel versions.

- 3101—2-1/2" Offset In/Offset Out Varitune Performance Muffler (Aluminized)
- 31015—2-1/2" Offset In/Offset Out Varitune Performance Muffler (Stainless Steel)
- 3102—2-3/4" Offset In/Offset Out Varitune Performance Muffler (Aluminized)
- 31025—2-3/4" Offset In/Offset Out Varitune Performance Muffler (Stainless Steel)
- 3103—3" Offset In/Offset Out Varitune Performance Muffler (Aluminized)
- 31035—3" Offset In/Offset Out Varitune Performance Muffler (Stainless Steel)
- 3104—2-1/2" Offset In/Center Out Varitune Performance Muffler (Aluminized)

- 31045—2-1/2" Offset In/Center Out Varitune Performance Muffler (Stainless Steel)
- 3105—3" Center In/Center Out Varitune Performance Muffler (Aluminized)
- 31055—3" Center In/Center Out Varitune Performance Muffler (Stainless Steel)
- 3106—2-1/2" Center In/Center Out Varitune Performance Muffler (Aluminized)
- 31065—2-1/2" Center In/Center Out Varitune Performance Muffler (Stainless Steel)
- 3107—3" Offset In/Center Out Varitune Performance Muffler (Aluminized)
- 31075—3" Offset In/Center Out Varitune Performance Muffler (Stainless Steel)

VARI-TUNE™ TUNABLE EXHAUST SYSTEMS

- + Bolt-On 15–25 HP
- + Adjust Sound In Just Minutes
- + 8–10 DB Range
- + Up To 10HP Over Other brands



PATENT# 8851231

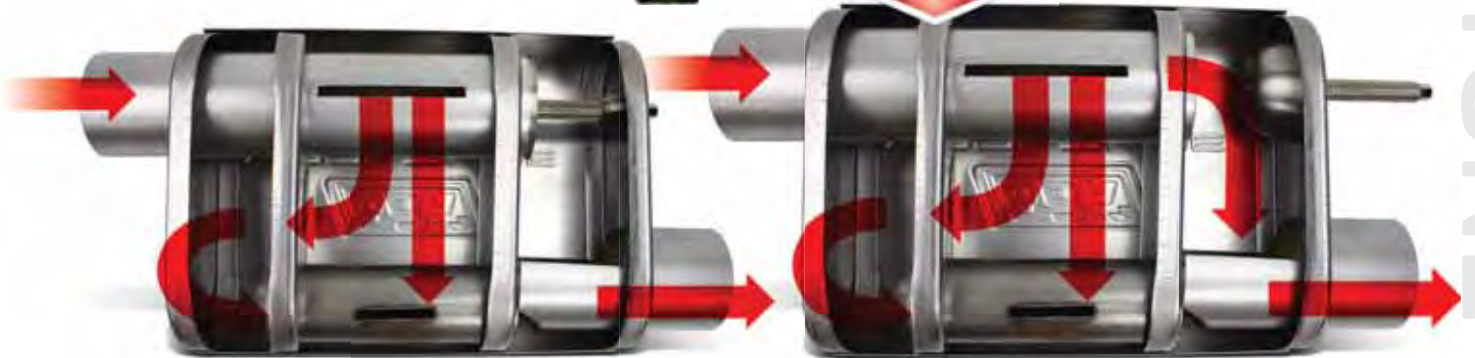

Utilizing our patented (patent number) fully tunable Varitune performance mufflers, owners of Detroit's top Pony cars can bolt-on Up to 30 rear wheel horsepower with one of our complete Varitune rear exhaust systems. Featuring computer mandrel bent 2-3/4" tubing, brushed 304 stainless steel 4" tips and direct fit hardware along with two of our 2-3/4" Varitune adjustable mufflers, each system is a true bolt. Check out www.bbkperformance.com or our BBK YouTube channel for videos of each of these systems to see the gains offered as well as the range of sound and performance available with our truly unique Varitune adjustable mufflers.

1986-04 MUSTANG GT CAT BACK SYSTEMS

- 3001—Varitune Cat Back System (1986 GT / 1987-1993 LX 5.0L / 1994-2004 GT)
- 3002—Varitune Cat Back System (1987-1993 GT)



When our engineering team tackled the popular Fox Body Mustang for our new Varitune performance cat back exhaust, they were able to design two systems that would fit the range of 1986-2004 Mustang GT & LX models. Each system comes complete with two of our patented Varitune 2-3/4" mufflers, full computer mandrel bent tubing and brushed 304 stainless tips on the 1987-93 LX 5.0L & 1994-2004 GT models. Our 1987-93 GT systems feature 2-3/4" turn down rear tailpipes to perfectly fit the factory GT rear valance.

2005-10 MUSTANG GT AXLE BACK SYSTEMS

- 4100—Varitune Axle Back System (2005-2010 Mustang GT – Aluminized Mufflers)
- 41005—Varitune Axle Back System (2005-2010 Mustang GT – Stainless Mufflers)



With easy tenability, a simple bolt-on design, computer mandrel bent 2-3/4" tubing, 4" brushed stainless steel tips and custom stainless steel couplers, our Varitune performance axle back exhaust for owners of the 2005-2010 GT models is unique to all other aftermarket systems. Featuring the only patented tunable performance mufflers this system really offers the best of both worlds with a mellow sound when needed and a awesome snarl when you desire making it perfect for the street or the track. Systems are available with either aluminized or stainless steel mufflers.

VARI-TUNE EXHAUST SYSTEMS

2011-15 MUSTANG GT AXLE BACK SYSTEMS

- 4101—Varitune Axle Back System
(2011-2014 Mustang GT – aluminized mufflers)
- 41015—Varitune Axle Back System
(2011-2014 Mustang GT – stainless mufflers)
- 4111—Varitune Axle Back System
(2015 Mustang GT – aluminized mufflers)
- 41115—Varitune Axle Back System
(2015 Mustang GT – stainless mufflers)



As with our 2005-2010 GT systems, our Varitune performance axle back exhaust delivers unmatched quality & value with our unique patented fully tunable mufflers. Each system is engineered as a true bolt-on design requiring no cutting or welding and will fit perfectly with your stock or aftermarket BBK high flow mid pipe assembly. Features in this kit are as follows (2-3/4" computer mandrel bent tubing, two Varitune adjustable performance mufflers, 4" brushed stainless steel tips and stainless couplers) Systems are available with aluminized or stainless steel mufflers.

2010-15 CAMARO SS AXLE BACK SYSTEMS

- 41065—Varitune Axle Back System
(2010-2015 Camaro SS – stainless mufflers)



Owners of the popular 2010-2015 Camaro SS models can add 15-25 horsepower along with a full range of sound settings with our Varitune performance axle back system. Featuring two of our patented 2-3/4" stainless steel Varitune fully tunable mufflers, computer mandrel bent tubing, 4" brushed stainless steel tips and stainless couplers this system will deliver a mellow but throaty sound or an all out raspy snarl depending on the muffler setting you pick that day.

2005-14 CHARGER / CHALLENGER AXLE BACK SYSTEMS

- 4107—2005-2010 Charger V8—aluminized
- 41075—2005-2010 Charger V8—stainless
- 4109—2006-2010 SRT-8 Charger—aluminized
- 41095—2006-2010 SRT-8 Charger—stainless
- 4108—2009-2014 Challenger—aluminized
- 41085—2009-2014 Challenger—stainless
- 4110—2008-2014 Challenger—aluminized
- 41105—2008-2014 Challenger—stainless



From the awesome 5.7L to the brute force 6.1L & 6.4L SRT8 Hemi applications, the modern day Chrysler Hemi engines back a lot of punch from the factory but also offer some phenomenal power gains with simple induction & exhaust upgrades. Our new Varitune performance axle back systems for you favorite Dodge Charger / Challenger models will deliver Up to 30 horsepower along with a fully tunable sound and power levels. Each system features two Varitune performance mufflers, computer mandrel bent tubing and stainless couplers for a simple installation. (Our beautiful hand crafted & polished stainless quad tips are standard on certain models)

VARTUNE
EXHAUST

LOWERING SPRING SYSTEMS

Engineered in conjunction with Eibach Spring Company, our lowering spring kits for late model Mustang, Camaro and Challenger owners are engineered for the daily driver looking for a better ride stance while retaining a good ride quality. Utilizing progressive rate coiling technology and only the highest quality materials these lowering spring kits are designed to meet or exceed the longevity of the factory units. Expect a drop of approximately 1-1/2" on most applications)



2501—Progressive Rate Lowering Spring Kit (1979-04 V8 Mustang)

POLYURETHANE SPRING ISOLATOR BUSHING KITS

When upgrading to lowering springs it's a great idea to at the same time swap out the factory rubber spring isolator bushings with these high quality polyurethane units which offer better performance and longevity over the rubber bushings that are usually worn when removed. All our Gripp polyurethane bushings are molded from the highest quality graphite impregnated urethane and are perfectly fitted for an easy install.



2545—Polyurethane Front Spring Isolator Kit (1979-04 Mustang)

2546—Polyurethane Rear Spring Isolator Kit (1979-04 Mustang)

GRIPP
SUSPENSION

POLYURETHANE OFFSET STEERING RACK BUSHING KIT

These polyurethane offset steering rack bushings are recommended when lowering your Mustangs ride height to ensure proper geometry and will also improve steering response over the stock rubber units.

2508—Polyurethane Offset Steering Rack Bushing Kit (1986-2004 Mustang)



POLYURETHANE BUMPSSTOP BUSHING

These polyurethane rear axle pinion snubber bushings are recommended with our Gripp lowering spring kits as they deliver the proper height for the new lowered stance

2531—Polyurethane Pinion Snubber Bushing (1979-04 Mustang)

1979-2014 MUSTANG ADJUSTABLE CASTER CAMBER KITS AVAILABLE

- + Now Available To Fit Up To 2014
- + Full CNC Construction

With many of today's Mustang enthusiasts putting as much emphasis on the handling characteristics as the horsepower potential of their pride and joy. It's become increasingly important to find the most functional, yet streetable parts for these applications. With the use of our caster/camber kits for 79-93, 94-04 and 05-14 Mustang applications, front end adjustment has become easy and affordable. Machined on our state-of-the-art CNC machining centers these caster/camber plates feature billet aluminum main bodies, polyurethane mounts, and full caster and camber adjustability. All kits include complete hardware and instructions to ensure an easy installation.

- *2525—Aluminum Adjustable Caster/Camber Package (1979-93 Mustang)
- *2527—Aluminum Adjustable Caster/Camber Package (1994-2004 Mustang)
- 2551—Aluminum Adjustable Caster/Camber Package (2005-2014 Mustang)
- 1610—Replacement Bushing/Hardware Kit (2525/2527)

**Will not work on a coil over suspension set up*



HEAVY DUTY BUMPSTEER KIT

Our Gripp performance heavy duty bump steer kits are a perfect handling upgrade and allow adjustment to ensure proper alignment geometry when installing lowering springs to your Mustang. Built from computer machined aluminum and fitted with only the highest quality heim joints, the units receive a graphite colored anodized finish for a perfect look with all Mustang colors.

- 2561—79-93 Mustang Heavy Duty Performance Bump Steer Upgrade Kit
- 2562—94-04 Mustang Heavy Duty Performance Bump Steer Upgrade Kit
- 2563—05-10 Mustang Heavy Duty Performance Bump Steer Upgrade Kit

HEAVY DUTY PERFORMANCE REAR CONTROL ARM SETS

Firmer launches and much improved handling characteristics are what you will get with these new heavy-duty rear upper and lower control arm kits for Mustang owners. Designed to work on all 1979-2014 Mustang applications, these units feature such highlights as precision robotic welding, baked on powdercoating and polyurethane bushings, complete with greaseable zerk fittings. Sold in pairs or as complete packages, these parts come with complete instructions for an easy installation.

- 2521—Rear Lower Control Arm Kit (1979-1998 Mustang)
- 25210—Rear Lower Control Arm Kit (1999-2004 Mustang)
- 25215—Rear Lower Control Arm Kit (2005-2014 Mustang)
- *2522—Rear Upper Control Arm Kit (1979-2004)
- *2526—Rear Upper and Lower Control Arm Package (1979-1998 Mustang)
- *25260—Rear Upper and Lower Control Arm Package (1999-2004 Mustang)
- 2523—Upper and Lower Control Arm Kit (2005-2010 Mustang)
- 2549—Lower Control Arm Replacement Bushings for BBK 2521/25210, 2526/25260
- 2550—Upper Control Arm Replacement Bushings for BBK 2522/2526/25260

**Does not fit IRS Cobra models.*



MUSTANG STRUT TOWER BRACES

- + All Precision Handcrafted Welds
- + Powdercoat Or Chrome Finishes
- + Direct Bolt-On Designs
- + Increases Front Structural Strength For Improved Handling Performance



No matter what year Mustang you are upgrading, these models are notorious for strut tower flex as they all use a variation of the Fox Chassis that dates back to the mid 70's. To dramatically increase chassis strength in the front strut tower area our engineers began engineering and producing our now famous strut tower braces which even caught on with the factory as even Ford is now installing a strut tower brace on current variations of there Mustang. Each unit is fully powder coated for maximum longevity and includes hardware for a simple do it yourself installation.

- *2504—Gripp Tubular Strut Tower Brace (1986-93 Mustang 5.0) – Gloss Black Powdercoat
- *25040—Gripp Tubular Strut Tower Brace (1986-93 Mustang 5.0) – Polished Chrome Finish
- *2513—Gripp Tubular Strut Tower Brace (1994-95 Mustang GT/Cobra 5.0) – Gloss Black Powdercoat
- *25130—Gripp Tubular Strut Tower Brace (1994-95 Mustang GT/Cobra 5.0) – Polished Chrome Finish
- *2516—Gripp Tubular Strut Tower Brace (1994-04 V-6, 1996-06 GT Models) – Gloss Black Powdercoat
- *25160—Gripp Tubular Strut Tower Brace (1994-04 V-6, 1996-06 GT Models) – Polished Chrome Finish
- **2617—Strut Tower Brace (2005-06 GT) – Titanium Powdercoat

**Does not fit 4V, Cobra, Mach1 or Bullet models.*

***Will not fit 07-08 models. Use BBK Competition Series for all applications*



MUSTANG SUBFRAME CONNECTORS

- + Heavy Duty Materials
- + Precision Welds
- + Improves Chassis Strength & Rigidity

Whether it's better street performance or the occasional weekend drag or road race event, nothing will help the handling performance and chassis strengthening as much as a set of Gripp® Series subframe reinforcement connectors from BBK. These super strong boxed steel connectors will give your unibody Mustang the support of a full-frame chassis. New kits are now also available which feature extra supportive "seat-mounting brackets" for additional strength and safety. All Gripp subframe connectors feature die-stamped brackets and hardware for a bolt-on application or can be welded in place for maximum strength. All connectors are fully sealed and powdercoated gloss grey metallic for maximum looks and quality. A must with flex prone convertible models

- *2506—Gripp Subframe Connector Set (Standard Style – 1979-93 Mustang)
- *2520—Gripp Subframe Connector Set (Standard Style – 1994-2004 Mustang)
- *2542—Gripp Subframe Connector Set (w/Seat Support Brackets – 1979-93 Mustang)
- *2543—Gripp Subframe Connector Set (w/Seat Support Brackets – 1994-2004 Mustang)

**Some Cobra models require removal of front bracket on subframe connector to clear trans. cross member.*



HEAVY DUTY ADJUSTABLE CLUTCH QUADRANT & CABLE KITS & FIREWALL ADJUSTERS

Our popular heavy-duty clutch cable and quadrant kits for 1979-04 Mustang models have been the number one system on the market for fifteen years and counting. While many other kits are now available in the aftermarket, none match the high-quality components or warranty found on our Gripp units. With our OEM style hard-cased heavy-duty adjustable cable, super strong aluminum one piece quadrant and 2-piece CNC machined blue anodized firewall adjuster, it's easy to see why these kits continue to be number one with Mustang enthusiasts. These easy to install systems work great on stock or heavy-duty clutch applications and will eliminate the notorious factory sticky shifts and hard to get reverse gear. The beautiful blue anodized firewall adjuster allows precise pedal adjustment from under the hood.



- 1505—Aluminum Clutch Quadrant and Adjustable Cable Kit (1979-95 Mustang GT & Cobra Mustang 5-Speed Models)
- 15055—Aluminum Clutch Quadrant and Adjustable Cable Kit (1979-95) with Firewall Adjuster
- 15050—Clutch Firewall Adjuster Kit 1979-2004
- 1609—Aluminum Clutch Quadrant and Adjustable Cable Kit (1996-2004 GT & Cobra Mustang 5-Speed Models)
- 16095—Aluminum Clutch Quadrant and Adjustable Cable Kit (1996-2004 GT & Cobra Mustang 5-Speed Models) & Firewall Adjuster



BILLET ALUMINUM FIREWALL ADJUSTER

This trick 2-piece Mustang firewall clutch adjuster is featured in some of our clutch quadrant and cable kits and is also available individually. Built from computer machined billet aluminum then blue anodized, it looks as great as it works

- 15050—Billet Aluminum Firewall Clutch Adjuster (1979-04 Mustang)

REPLACEMENT HEAVY DUTY ADJUSTABLE CABLES

Our heavy duty adjustable Mustang clutch cables feature a heavy duty casing and super strong wound steel cable for maximum strength for all clutch performance levels. Fitted with a fully adjustable end and locking nut, these cables are designed to be used with our heavy duty clutch quadrant and will also work with our firewall adjuster. Our trick one piece heavy duty clutch quadrant is computer machined to aircraft standards from billet aluminum for maximum strength and allows for full adjustment for all 1979-04 Mustang 5-speed models. Included on all quadrant/cable kits.



- 3517—Heavy Duty Adjustable Clutch Cable (1979-95 Mustang V8 Models)
- 3519—Heavy Duty Adjustable Clutch Cable (1996-04 Mustang GT/Cobra Models)

NEW 2015-2016

GT, ECOBOOST AND V6



The Mustang 5.0L and the BBK brand have gone side by side since the late 1980's when our team released the aftermarket's first cold air intakes, performance throttle bodies and other now industry standard performance upgrades. While the stock 5.0L motor has grown from 225HP in the early models to over 420HP in the modern Coyote versions, our world famous BBK performance bolt-on's still provide the most bang for the buck with unsurpassed quality making them the standard others try to follow. Our line of 2015-2016 Mustang products covers the full range of Ecoboost, V6 and GT applications with more proven horsepower gains than ever. Be sure to visit www.bbkperformance.com for our latest Mustang offerings, product video's and performance data.



Axle Back System



Cat Back System

VARITUNE EXHAUST

Our popular Varitune rear exhaust systems are now available for the 2015-2016 Mustang GT models with new kits in development for the V6 / Ecoboost versions. Using a pair of our patented fully tunable Varitune stainless steel mufflers, these systems deliver unmatched sound and performance characteristics with the ability to adjust sound & performance levels with the twist of a wrench.

NEW 41115—Varitune Axle Back System (2015-2016 Mustang GT)

NEW 30065—Varitune Cat Back System / Includes Resonator Delete X-Pipe (2015-2016 Mustang GT)

GT RESONATOR DELETE

Add 8-12 horsepower and increase the growl of your 2015-2016 Mustang GT with this simple to install resonator delete x-pipe. Made from the highest quality computer mandrel bent aluminized material, these delete pipes are made as well as they perform.



NEW 1818—Resonator Delete X-Pipe (2015-2016 Mustang GT)

3" GT ADAPTER KIT

For those of you wanted to go with a full 3" exhaust system to compliment other power adders like a supercharger, our BBK engineers came up with this trick 3" conversion adapter kit that transitions our long tube header mid pipe to 3" all the way to a new 3" resonator delete x-pipe and couples to our 2015-2016 GT cat back system which is already at a 3" diameter.

NEW 18180—3 Inch High Flow Mid-Pipe / Resonator Delete Kit (2015-2016 Mustang GT)

MUSTANG PERFORMANCE PRODUCTS

AIR INTAKE SYSTEMS

Since 1988 BBK Air Intakes have been the number one systems for Mustang enthusiasts and our latest systems for 2015-2016 Mustang owners are no exception. With our hand polished chrome finish or sinister "Blackout Series" – BBK air intake systems will deliver up to 15 rear wheel HP with your stock or aftermarket tune.

- NEW 1850**—2015-2016 Ecoboost Air Intake System (Chrome)
- NEW 18505**—2015-2016 Ecoboost Air Intake System (Blackout)
- NEW 1846**—2015-2016 V6 Air Intake System (Chrome)
- NEW 18465**—2015-2016 V6 Air Intake System (Blackout)
- NEW 1847**—2015-2016 GT Air Intake System (Chrome)
- NEW 18475**—2015-2016 GT Air Intake System (Blackout)

PERFORMANCE THROTTLE BODIES

As the first company to bring a performance throttle body to the market, BBK has been the leader in this category with what is now the largest line of aftermarket throttle bodies in the world. For 2015-2016 Mustang models, we have Ecoboost, V6 and GT models fully covered with specific fully calibrated units for all models.

- NEW 1894**—65mm Power-Plus Series Throttle Body (2015-2016 Mustang Ecoboost)
- NEW 1822**—73mm Power-Plus Series Throttle Body (2011-2016 Mustang V6)
- NEW 1806**—85mm Power-Plus Series Throttle Body (2015-2016 Mustang GT)
- NEW 1807**—90mm Power-Plus Series Throttle Body (2015-2016 Mustang GT)

ECOBOOST DOWN PIPES

Our all new high flow downpipes deliver unmatched horsepower gains with there full 3" deign, custom stainless mesh flex joint and optional 3" high flow steel core converter. Coupled with a BBK air intake, throttle body and a custom tune and your Ecoboost can kick out performance numbers seen by the factory 5.0L Coyote models with almost 30MPG.

- NEW 1809**—3" High Flow Catted Downpipe (2015-2016 Mustang Ecoboost)
- NEW 18090**—3" High Flow Off Road Downpipe (2015-2016 Mustang Ecoboost)

V6/GT TUNED LENGTH HEADERS

As the originator of the tuned-length shorty headers, our latest BBK performance headers for 2015-2016 V6 & GT owners deliver the most horsepower gains while retaining the stock converter locations and smog legal status (pending on GT models) Available in either chrome or polished ceramic finishes our BBK tuned length headers are built to look great and last the life of your pride & joy.

- NEW 1442**—1-5/8" Tuned Length Headers (2011-2016 Mustang V6 / Chrome)
- NEW 14420**—1-5/8" Tuned Length Headers (2011-2016 Mustang V6 / Polished Ceramic)
- NEW 1848**—1-3/4" Tuned Length Headers (2015-2016 Mustang GT / Chrome)
- NEW 18480**—1-3/4" Tuned Length Headers (2015-2016 Mustang Gt / Polished Ceramic)

LONG TUBE HEADERS WITH MATCHING PIPES

Since 1988 BBK long tube header systems have set the standards and led the pack with Mustang enthusiasts with there unmatched quality, performance & value. For 2015-2016 owners we offer some great choices which will allow for some serious horsepower with simple bolt-on designs that work great on the street or at the track.

- NEW 1633**—1-5/8" Long Tube Headers (2011-2016 Mustang GT / Chrome)
- NEW 16330**—1-5/8" Long Tube Headers (2011-2016 Mustang GT / Polished Ceramic)
- NEW 1856**—1-7/8" Long Tube Headers (2011-2016 Mustang GT / Chrome)
- NEW 18560**—1-7/8" Long Tube Headers (2011-2016 Mustang GT / Polished Ceramic)

MATCHING HIGH FLOW MID PIPES

- NEW 1816**—High Flow 3" Catted Mid Pipe Kit (Use with BBK 2015-2016 GT Long Tube Headers)
- NEW 18160**—High Flow 3" Off Road Mid Pipe Kit (Use with BBK 2015-2016 GT Long Tube Headers)
- NEW 16332**—O2 Harness & Hardware Install Kit (Must be used to install above long tube headers on 2015-2016 Mustang GT models)



CAREERS

Our BBK team of dedicated enthusiasts is constantly expanding to meet the needs of our growing BBK performance product line. With facilities in Southern California & Central Florida we offer a variety of positions spread out between our R&D, production, distribution and sales & marketing departments. Please visit our website at www.bbperformance.com for our most recent career posting and to fill out our on line application.



FREE PRODUCTS

In order to design & test hundreds of products on dozens of different vehicles each year as well as produce a constant flow of how too video content, our R&D teams in both Southern California & Central Florida are always on the lookout for additional test vehicles. In return for use of these vehicles, each consumer receives a variety of free BBK product which is also installed at no cost. That's right, 100% free BBK performance products installed at no cost. To have a chance at being one of the dozens of lucky enthusiasts that are chosen each year please visit our website at www.bbperformance.com for a recent listing of vehicles needed by location and to fill out an on line vehicle submission.



MERCHANDISE

With almost 30 years as the leading brand of performance products for the current generation of fuel injected cars & trucks, enthusiast can enjoy our selection of BBK apparel & merchandise. From hats & t-shirts to our mechanic button up shirts & jackets, all BBK merchandise is sourced from the highest quality brands such as RedCap & Dickies to ensure only the best fit and long term wear. In addition to apparel items we also offer some cool beer Koozies & mouse pads for some great stocking stuffers. All BBK apparel items are available in most popular sizes and can be purchased on our website at www.bbkperformance.com or at one of our two BBK factory outlets located in Temecula, California or DeLand, Florida.



BBK BASEBALL CAPS IN NAVY BLUE

\$14.99EA

BBK LIGHTWEIGHT T-SHIRTS IN GREY (S,M,L & XL)

\$19.99EA



BBK MECHANICS SHIRTS IN NAVY BLUE OR GREY (S,M,L & XL)

\$29.99EA



BBK MECHANICS JACKETS IN NAVY BLUE (S,M,L & XL)

\$49.99EA



BBK BEER KOOZIES & MOUSE PADS

\$4.99EA

VISIT OUR **EAST & WEST COAST** FACTORY OUTLET SHOWROOMS

Whether you live near or are visiting sunny Florida or California, be sure to stop in and visit one of our fully stocked BBK factory outlet showrooms. In addition to a full inventory of your favourite BBK performance products, these outlets put on annual customer appreciation events with hundreds of cars in attendance, free dyno testing and fun for the entire family. Our Deland, Florida showroom also offers full installation and dyno services and is located just 20-minutes south of Daytona Beach and approximately 30-minutes north of Orlando. The Deland showroom is open Monday - Friday 8am to 5pm and Saturday 10am to 4pm.

Our Temecula, CA location is also home to our extensive factory featuring our state of the art CNC machine and weld divisions as well as our full research & development center. The Temecula showroom is open Monday to Friday 8am to 4pm. Once a year during the annual customer appreciation event, enthusiasts are invited on a guided tour of this facility which is located halfway between San Diego and Los Angeles.



**FOLLOW OUR BLOG FOR UPDATED
NEWS AND EVENTS**

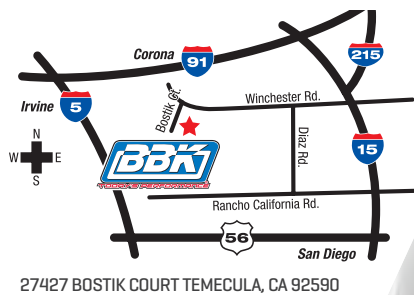

JOIN US FOR OUR CUSTOMER APPRECIATION CAR SHOW & SALES EVENT

Visit our website for dates and full event details



BBK Performance
www.bbperformance.com Channel [Subscribe](#) [Playlists](#) [Uploads](#)



SUBSCRIBE TO OUR CHANNEL TODAY

- + New videos produced daily
- + Dyno tests
- + How to install videos

In order to educate enthusiasts with performance results as well as "how to" install information, the BBK team is ramping up our video production department and are adding new videos each week to our YouTube channel as well as our website at www.bbperformance.com. Be sure to check out these exciting videos as we cover hundreds of BBK products in detail at our in house R&D facility complete with two Dynojet chassis dynos.

Info Comments Favorites Share Playlists Flag



Join our Facebook Page
www.facebook.com/bbkperformance



Follow us on Twitter
[@bbkperformance](https://twitter.com/bbkperformance)



Check us out on YouTube
www.youtube.com/bbkperformance



EVENTS



Corporate Headquarters & Sales Department

27440 Bostik Court, Temecula, California 92590
Tel: (951) 296-1771 Fax: (951) 296-9024
sales@bbkperformance.com

West: California Distribution Center, 27427 Bostik Court, Temecula, California 92590

East: Florida Distribution Center, 3060 Performance Circle, Deland, Florida 32724

SUBSCRIBE TODAY



- + New videos produced daily
- + Dyno tests
- + How to install videos

In order to educate enthusiasts with performance results as well as "how to" install information, the BBK team is ramping up our video production department and are adding new videos each week to our YouTube channel as well as our website at www.bbkperformance.com. Be sure to check out these exciting videos as we cover hundreds of BBK products in detail at our in house R&D facility complete with two Dynojet chassis dyno's.



W W W . B B K P E R F O R M A N C E . C O M